

#MAGNETI MARELLI MJD9 1.3 FIAT MJD 9DF
#MAGNETI MARELLI IAW-9GF 1.2 8V
#MAGNETI MARELLI MJD 1.3 FIAT, OPEL, SUZUKI. 6JO, 6JF, 6O2, 6O3, 6F3
#MAGNETI MARELLI MJD8 1.3 FIAT. 8F2, 8F3, 8GSF, 8GSW, 8GMF, 8DF, 8GMK, SUZUKI 8DS
#MAGNETI MARELLI FIAT/FORD IAW 5SF8, IAW 5SF9 , IAW 5SF3
#MAGNETI MARELLI FIAT IAW 5NF.XX
#MAGNETI MARELLI FIAT IAW 4AF
#MAGNETI MARELLI FIAT IAW 59F/5AF/4AF
#MAGNETI MARELLI FIAT IAW 5SF4,IAW 5SF.XX
#SID801, SID801A, SID802, SID803, SID803A, SID804, SID805, SID806
#SID201
#SIM22, SIM24, SIM28, SIM29, SIM210
#DUCATI SIEMENS/CONTINENTAL M3C
#SIMTEC 71 (Kline), SIMTEC 71.1 (Kline), SIMTEC 71.5 (CAN) , SIMTEC 71.6 (CAN)
#SIMTEC 75 (CAN) , SIMTEC 77 (CAN), SIMTEC 78 (CAN)
#GM Siemens/Continental D52
#OPEL SIMTEC 70
#OPEL SIMTEC 81, SIMTEC81.1
#OPEL BOSCH ME7.6.1 / ME7.6.2
#OPEL BOSCH ME155 / ME76H4
#KIA/HYUNDAI Siemens/ Continental SIM2K-34VR
#KIA/HYUNDAI Siemens/ Continental SIMK31
#MAZDA 3,5,6 DENSO RF7 ECU
#MAZDA 2 2010> 1.5 DENSO ECU
#MAZDA RX8 DENSO 64F7055
#MAZDA 3 2007 1.6 16V DENSO ECU
#OPEL 3.0CDTI DENSO VECTRA C / SIGNUM2005-2008
#OPEL 1.7CDTI 110CV,125CV DENSO ECUZ17DTJ, Z17DTR, Z17DTH,A17DTH,A17DTR
#OPEL 1.7 DENSO HYBRID ECU,CORSA-C, MERIVA
#SUZUKI 1.3/1.5/1.6 DENSO 64F7055, 64F7058
#SUZUKI JIMNY 1.3 85ps DENSO 64F7055
#SUZUKI GRAND VITARA DENSO 64F7055,64F7058
#MITSUBISHI DELICA D5 2.2DID 4N14 DENSO 64F7059
#MITSUBISHI 2.5 DID 136CVL200/PAJERO-4D56/4M41
#MITSUBISHI OUTLANDER 2.2DID 4N14 DENSO 64F7059
#MITSUBISHI ASX >2009 1.8DID 4N13 DENSO 64F7058
#SUBARU FORESTER 2007 2.0D 150hp KH DENSO 64F7058
#NISSAN NAVARA/PATHFINDER 2.5DCI 174CV 2005-2009
#Volvo V50/S40 2006-2010 140/170hp 64F7058
#Volvo V70/S60/S80 140/170hp DENSO 64F7058,64F7055
#Volvo S80/XC90 4.4L V8 2007-2010 DENSO 64F7058
#Volvo XC90/S80 3.2L YC 2007 - 2012 DENSO 64F7058
#Volvo XC60/V70/XC70/S80 3.0L T6 YF 2007 - 2012 DENSO 64F7058
#JAGUAR/LANDROVER P3.0NA / JAGUAR XF 4.2SC DENSO 64F7058
#OPEL/SAAB TRIONIC 8
#OPEL/MAZDA/FORD BOSCH EASYTRONIC
#SIMOS 3.3A, SIMOS 3.4A, SIMOS 3PA, SIMOS 3PB, SIMOS 3PC, SIMOS 3PD, SIMOS 3PE
#VAG SIMOS 6.2
#VAG SIMOS 7.1, SIMOS 7.1A

#VAG SIMOS 9.1
#VAG BOSCH ME7.5/ME7.5-1M/ME7.1/ME71.1-1M/ME7.1.1
#VAG BOSCH ME7.5.10
#VAG BOSCH EDC15
#VAG BOSCH MED7.5.11
#VAG BOSCH ME7.5.20
#MB BOSCH EDC15C6
#FIAT BOSCH ME731 BOOT
#FIAT BOSCH ME73H4 BOOT
#FIAT BOSCH ME7.6.3
#FIAT/ALFA/LANCIA/ABARTH BOSCH ME7.9.10
#FIAT/ALFA/LANCIA BOSCH EDC15C7 SPECIAL
#HONDA BOSCH ME7.9.3
#TOYOTA BOSCH ME7.9.51
#TOYOTA BOSCH M7.9.52
#TOYOTA BOSCH M7.9.5 / ME7.9.5
#TOYOTA BOSCH EDC15C9
#PSA BOSCH M7.4.4
#PSA BOSCH ME7.4.4
#PSA BOSCH ME7.4.5
#PSA BOSCH EDC15C2 1 Connector
#PSA BOSCH EDC15C2 3 Connectors SPECIAL
#JEEP/CHRYSLER BOSCH EDC15C5
#HYUNDAI BOSCH/KEFICO ME7.9.0
#KIA/HYUNDAI/HONDA/FIAT BOSCH EDC15C7
#VOLVO BOSCH EDC15C3
#VOLVO BOSCH EDC15C11
#VOLVO BOSCH ME7.0
#VOLVO BOSCH EDC16C31
#VOLVO BOSCH EDC16C34
#VOLVO BOSCH ME9.0
#VOLVO SIEMENS EMS2000
#SUZUKI MAGNETI MARELLI 8DS
#SMART BOSCH ME7.7.0
#SMART BOSCH EDG15C-5.X
#LAND ROVER RANGE ROVER AJ33 4.2 DENSO 64F7058
#MB BOSCH EDC15C6
#BMW BOSCH EDC15C4 SPECIAL
#BMW MINI/ROVER Siemens EMS
#BMW MINI/ROVER Siemens EMS2
#BMW MINI Siemens EMS5150
#LAND ROVER EDC15C4 SPECIAL
#GM ME7.9.9 Chevrolet Captiva/Opel Antara 2.4L
#Jaguar S-Type 4.2 V8 V8SC DENSO 64F7058
#SUBARU OUTBACK 2.0D NG/NN DENSO 64F7059
#MAZDA 6 2.2TD R2AC DENSO 64F7058
#FORD SIEMENS/CONTINENTAL EMS2101,EMS2102, EMS2103

#GM Siemens/Continental 42R

#GM Siemens/Continental D42

#FIAT IAW 7GF WIRING DIAGRAMS

#SUZUKI GRAND VITARA 2.4 DENSO 64F7058

#VAG IAW 9GV WIRING DIAGRAMS

#FIAT IAW 10GF WIRING DIAGRAMS

#FIAT IAW 9GF WIRING DIAGRAMS

MAGNETI MARELLI MJD 1.3 FIAT, OPEL, SUZUKI. 6JO, 6JF, 6O2, 6O3, 6F3

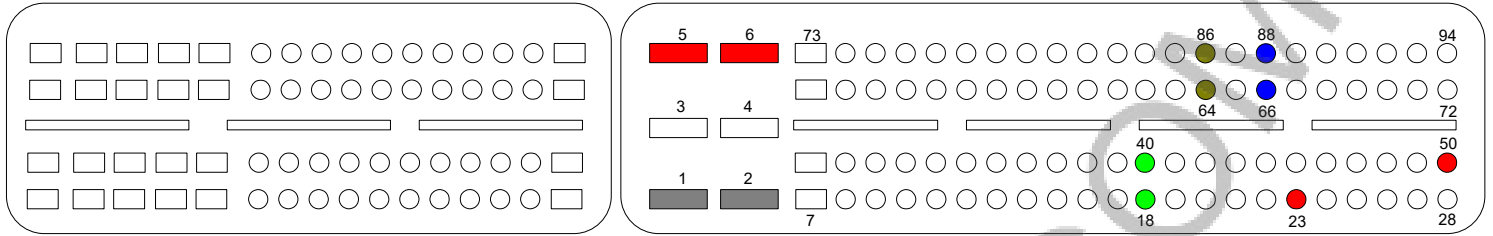

+12V	GND	CANH	CANL	KLINE FIAT	KLINE OPEL
5,6,23,50	1,2	64,86	18,40	88	66

MAGNETI MARELLI MJD8 1.3 FIAT. 8F2, 8F3, 8GSF, 8GSW, 8GMF, 8DF, 8GMK, SUZUKI 8DS

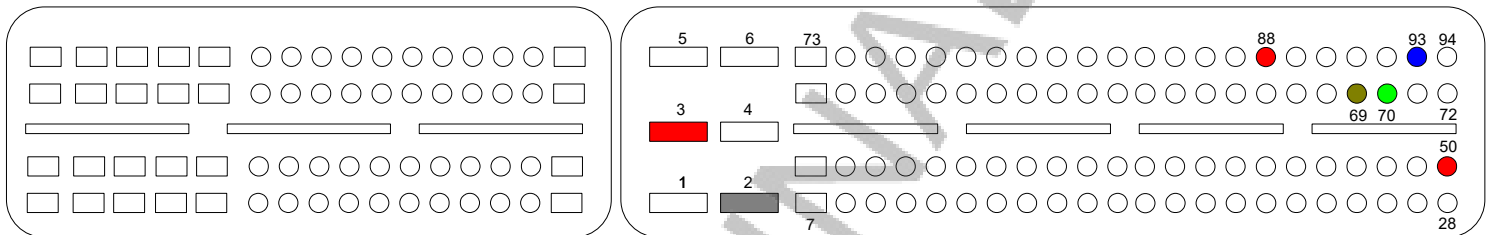

+12V	GND	CANH	CANL	KLINE
3,50,88	2	69	70	93

MAGNETI MARELLI FIAT/FORD IAW 5SF8, IAW 5SF9, IAW 5SF3

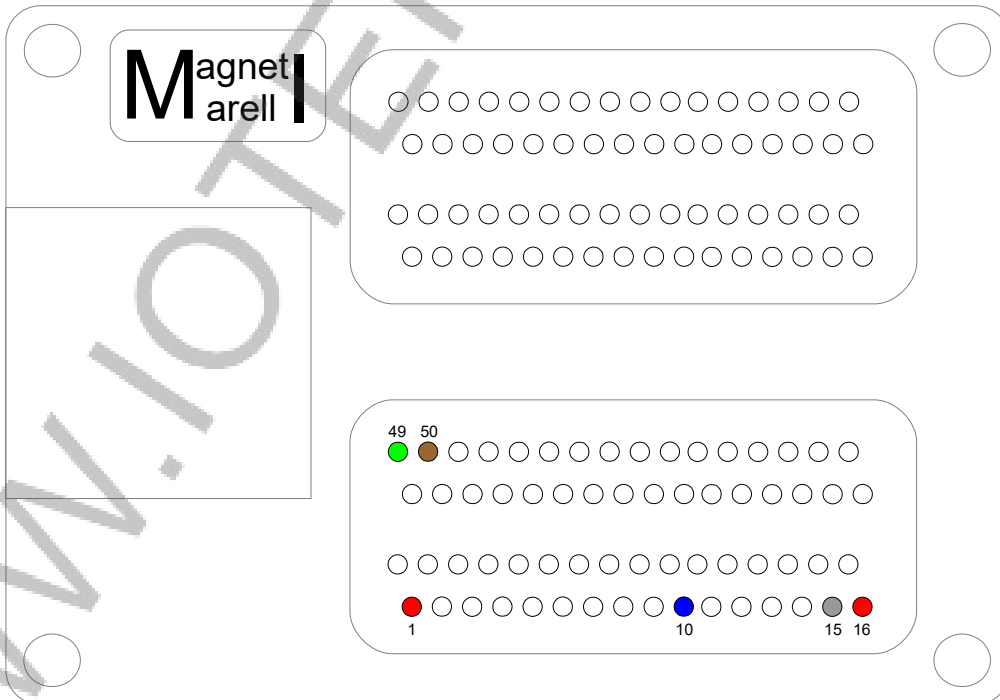

+12V	GND	CANH	CANL	KLINE
1,16	15	50	49	10

MAGNETI MARELLI FIAT IAW 5NF.XX

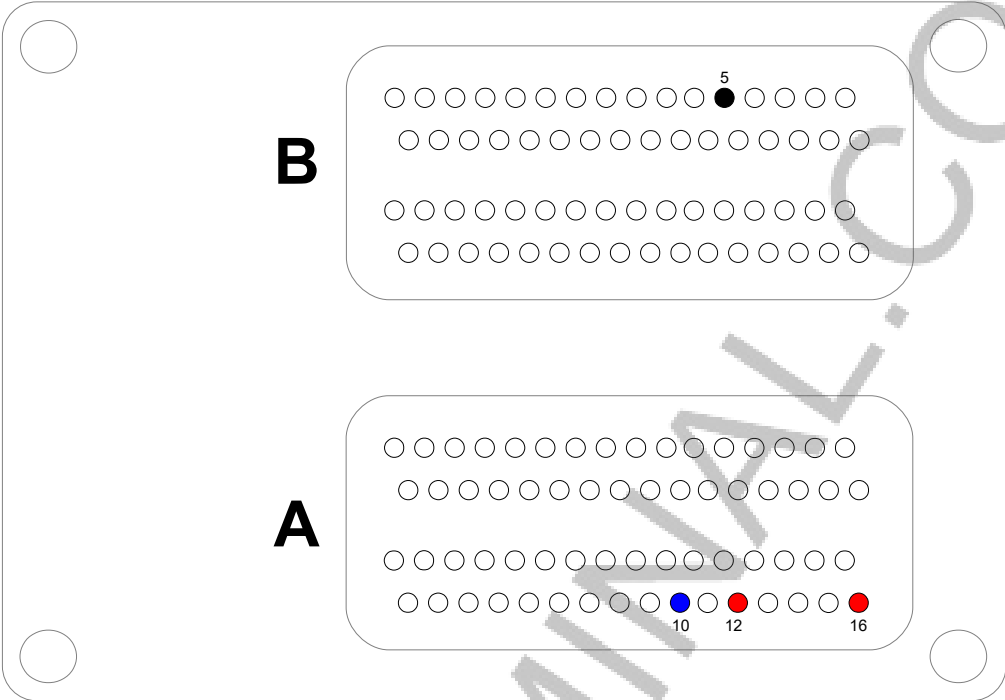

+12V	GND	KLINE
A12,A16	B5	A10

MAGNETI MARELLI FIAT IAW 59F/5AF/4AF

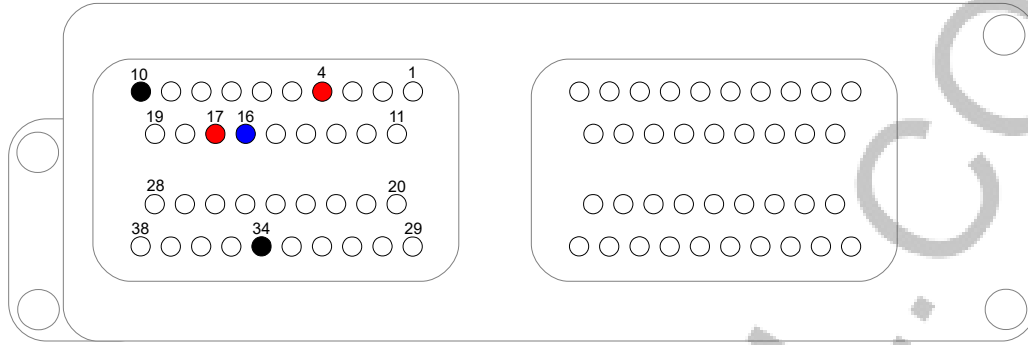

+12V	GND	KLINE
4,17	10,34	16

MAGNETI MARELLI FIAT IAW 5SF4, IAW 5SF.XX

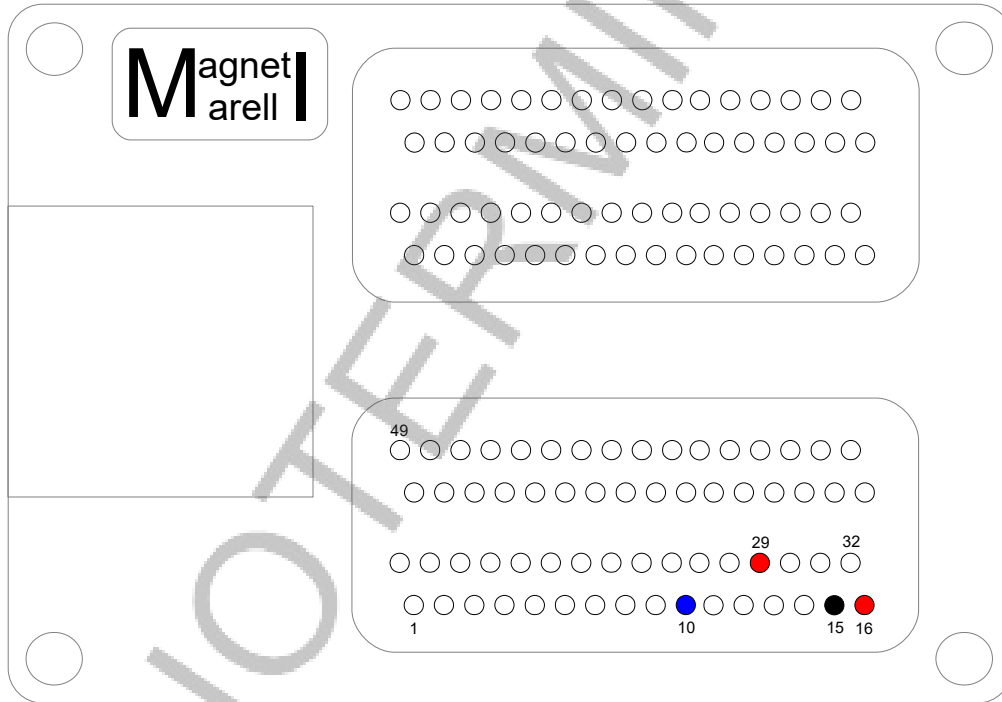

+12V	GND	KLINE
16,29	15	10

SID801, SID801A, SID802, SID803, SID803A, SID804, SID805, SID806

Z1

Z2

Z3

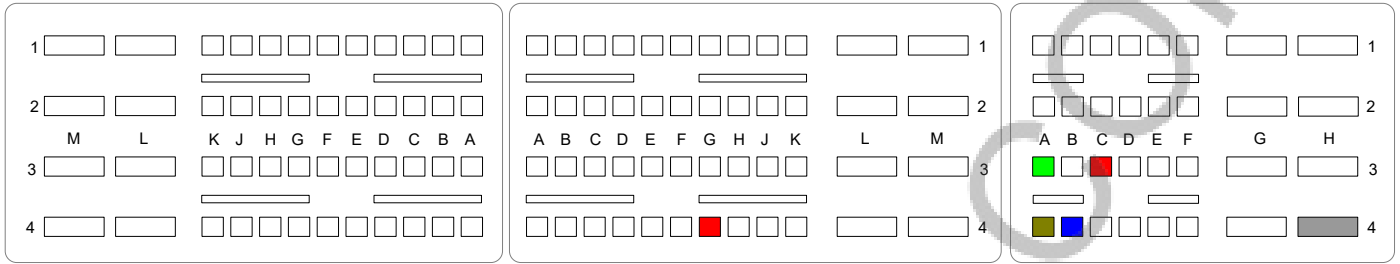

+12V	GND	CANH	CANL	KLINE
Z3 - C3, Z2 - G4	Z3 - H4	Z3 - A4	Z3 - A3	Z3 - B4

SID201

Z1

Z2

Z3

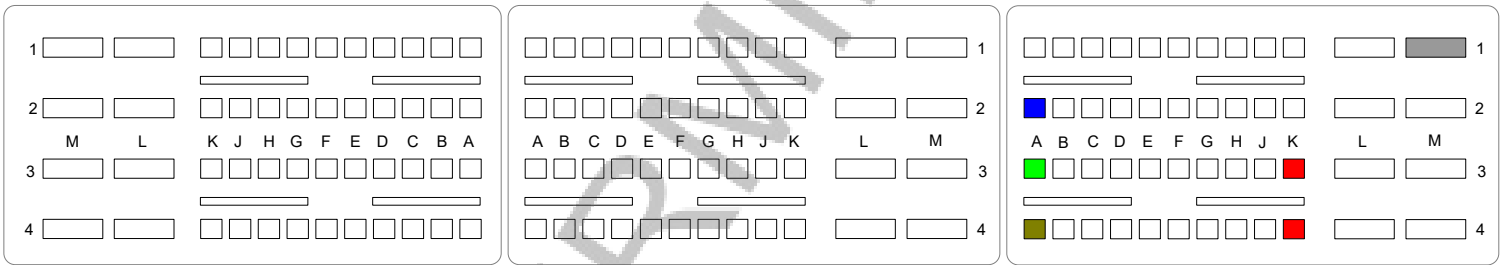

+12V	GND	CANH	CANL	KLINE
Z3 - K3, Z3 - K4	Z3 - M1	Z3 - A4	Z3 - A3	Z3 - A2

SIM22, SIM24, SIM28, SIM29, SIM210

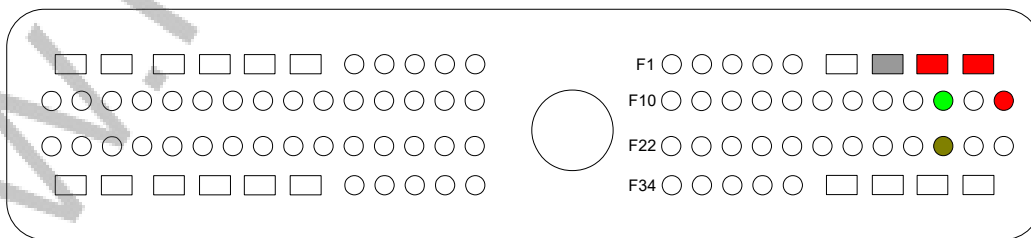

+12V	GND	CANH	CANL
F8, F9, F21	F7	F31	F19

VAG

SIMOS 3.3A, SIMOS 3.4A, SIMOS 3PA, SIMOS 3PB, SIMOS 3PC, SIMOS 3PD, SIMOS 3PE, SIMOS 7.1, SIMOS 7.1A

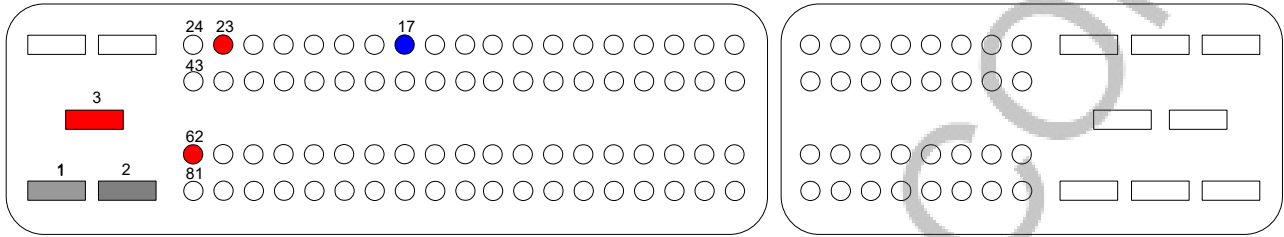

+12V	GND	KLINE
3,23,62	1,2	17

VAG SIMOS 6.2

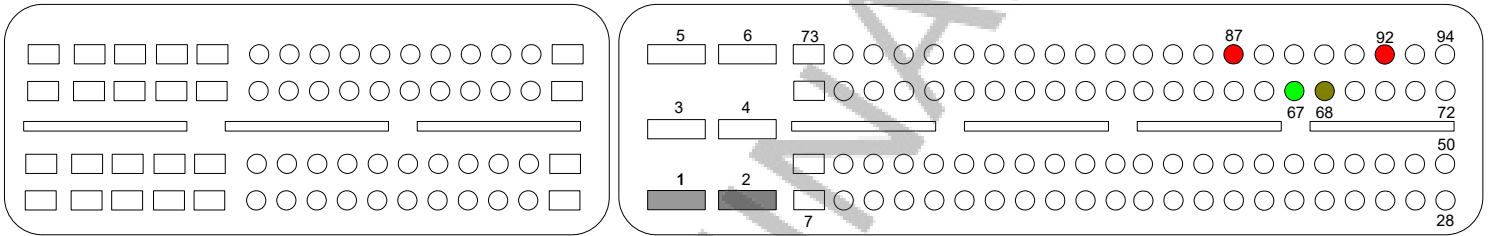

+12V	GND	CANH	CANL
87,92	1,2	68	67

DUCATI SIEMENS/CONTINENTAL M3C

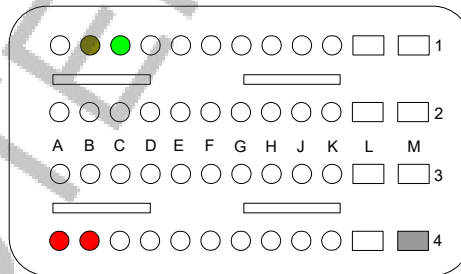

+12V	GND	CANH	CANL
A4,B4	M4	B1	C1

VAG SIMOS 9.1

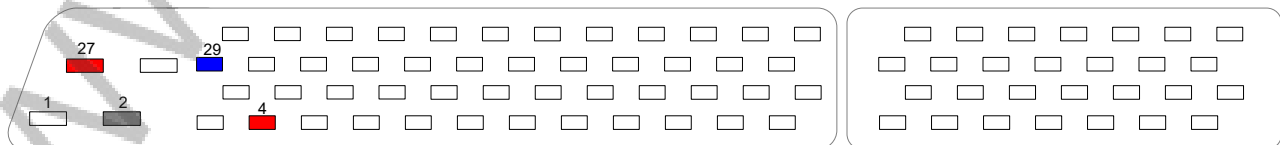

+12V	KLINE	GND
4,27	29	2

SIMTEC 71 (Kline), SIMTEC 71.1 (Kline), SIMTEC 71.5 (CAN) , SIMTEC 71.6 (CAN)

SIMTEC 71.1, SIMTEC 71.6

SIMTEC 71, SIMTEC 71.5

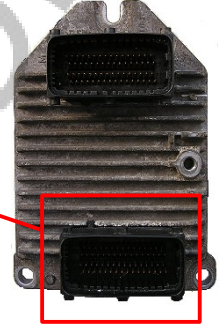
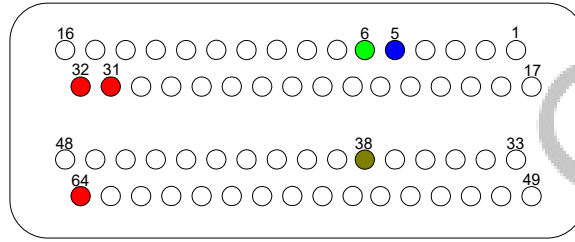
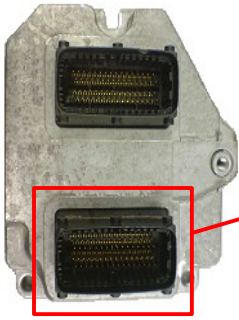

+12V	+12V IGNITION	GND	CANH	CANL	KLINE
31,32	64	ECU Case	38	6	5

SIMTEC 75 (CAN) , SIMTEC 77 (CAN), SIMTEC 78 (CAN)

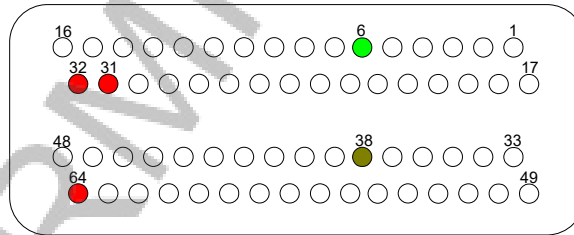
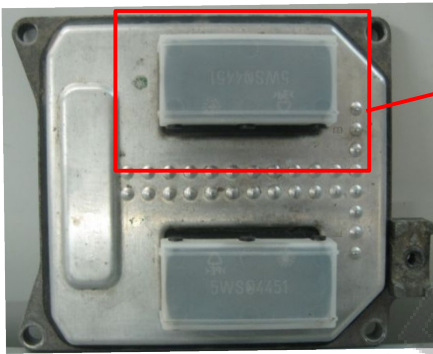

+12V	+12V IGNITION	GND	CANH	CANL
31,32	64	ECU Case	38	6

OPEL SIMTEC 70

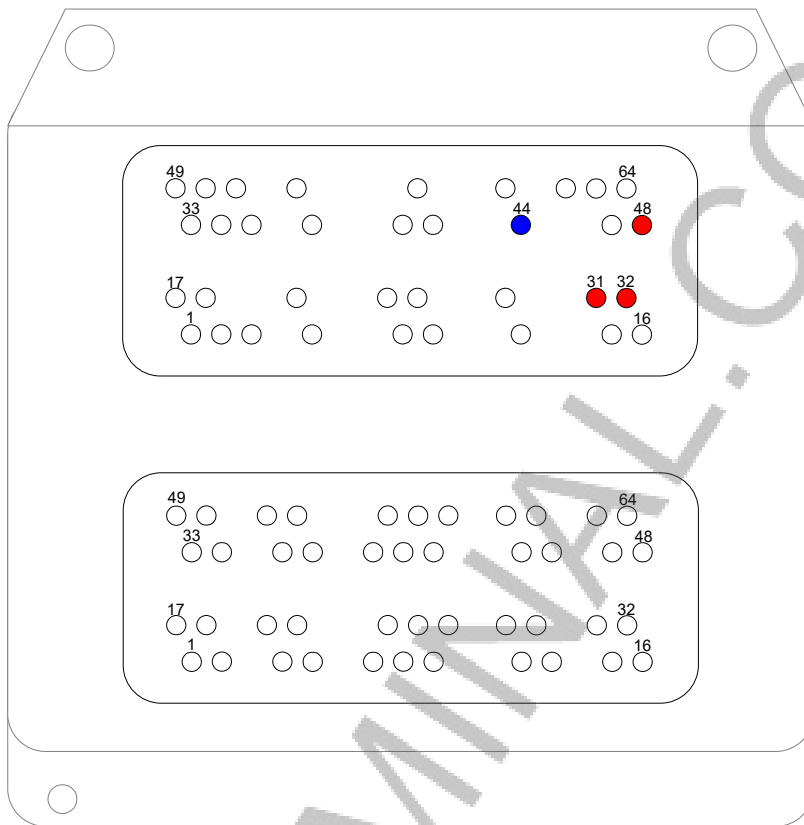

+12V	GND	KLINE
31,32,48	ECU Case	44

OPEL SIMTEC 81, SIMTEC81.1

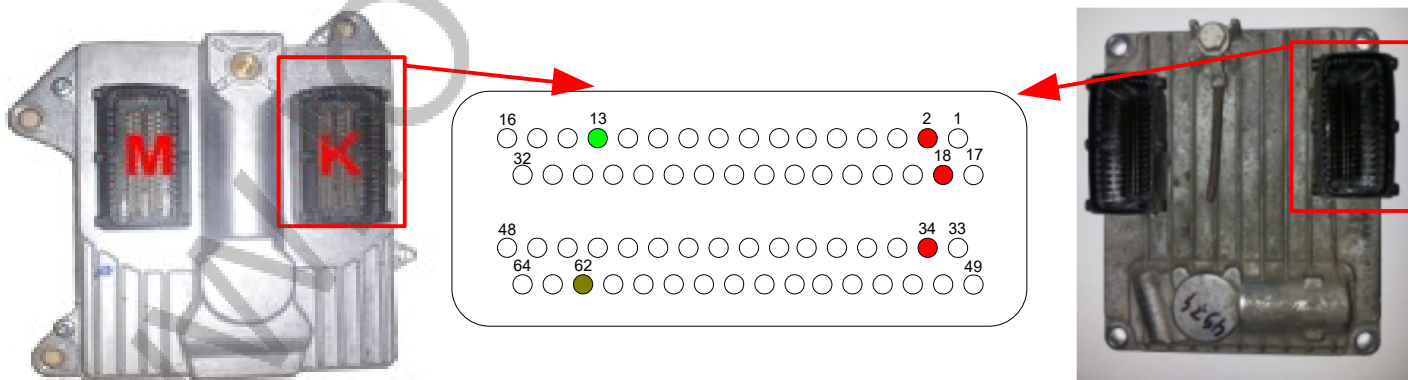

+12V	GND	CANH	CANL
2,18,34	ECU Case	62	13

KIA/HYUNDAI Siemens/Continental SIM2K-34VR

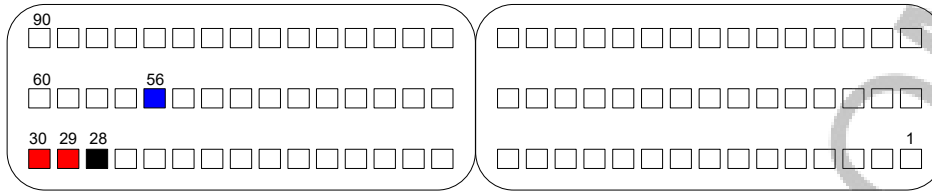

+12V	GND	KLINE
29,30	28	56

KIA/HYUNDAI Siemens/ Continental SIMK31

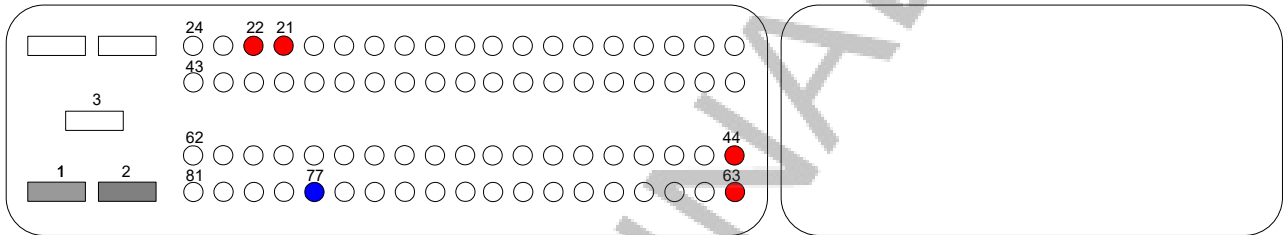

+12V	GND	KLINE
21,22,44,63	1,2	77

GM Siemens/Continental D52

GM Siemens/Continental 42R

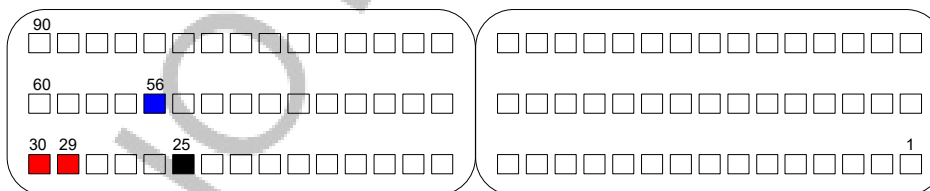

+12V	GND	KLINE
29,30	25	56



FLASH - 29F400BB
EEPROM
EMULATED INSIDE
FLASH

MAZDA 3,5,6 DENSO RF7 ECU

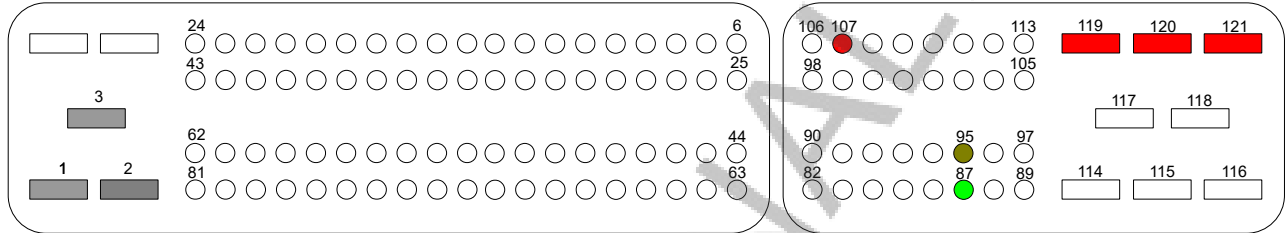

+12V	+12V AFTER MAIN RELAY ON	+12V IGNITION	CANH	CANL	GND
121	119,120	107	95	87	1,2,3

MAZDA 2 2010> 1.5 DENSO ECU

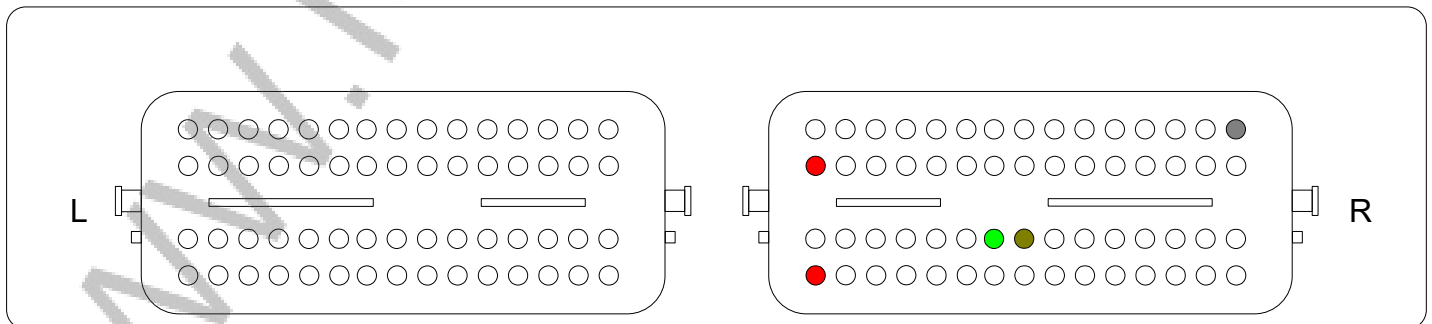

+12V	CANL	CANH	GND
------	------	------	-----

**OPEL 3.0CDTI DENSO VECTRA C / SIGNUM
2005-2008**

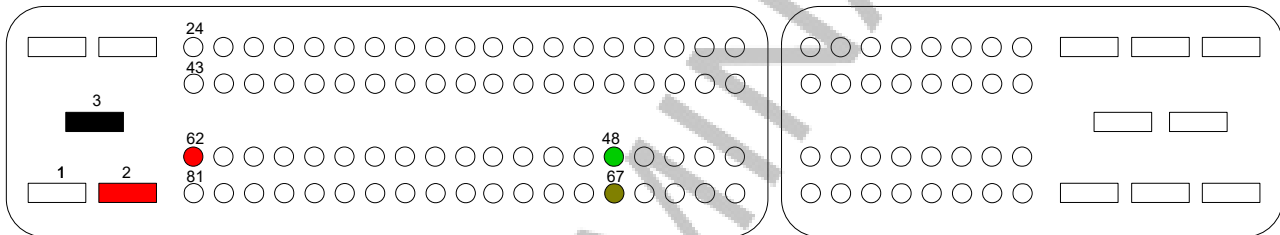

+12V	GND	CANH	CANL
2,62	3	67	48

**OPEL 1.7CDTI 110CV,125CV DENSO ECU
Z17DTJ, Z17DTR, Z17DTH,A17DTH,A17DTR
ASTRA H, ASTRA J, ZAFIRA B , CORSA D, MERIVA B,
TIGRA B**

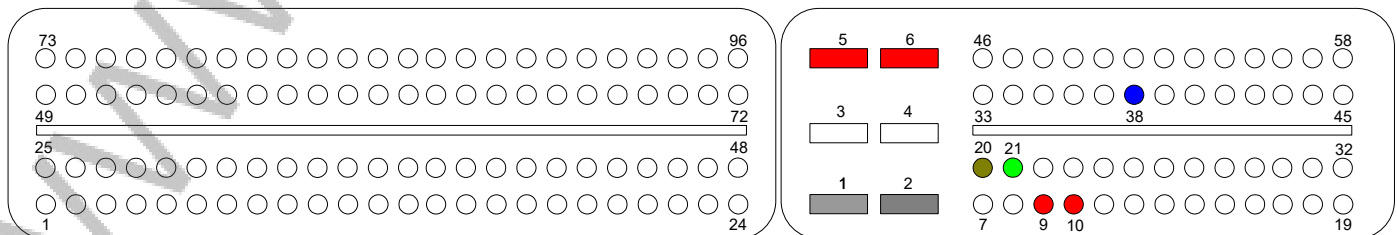

+12V	+12V IGNITION	CANH	CANL	KLINE	GND
5,6	9,10	20	21	38	1,2

OPEL 1.7 DENSO HYBRID ECU, CORSA-C, MERIVA

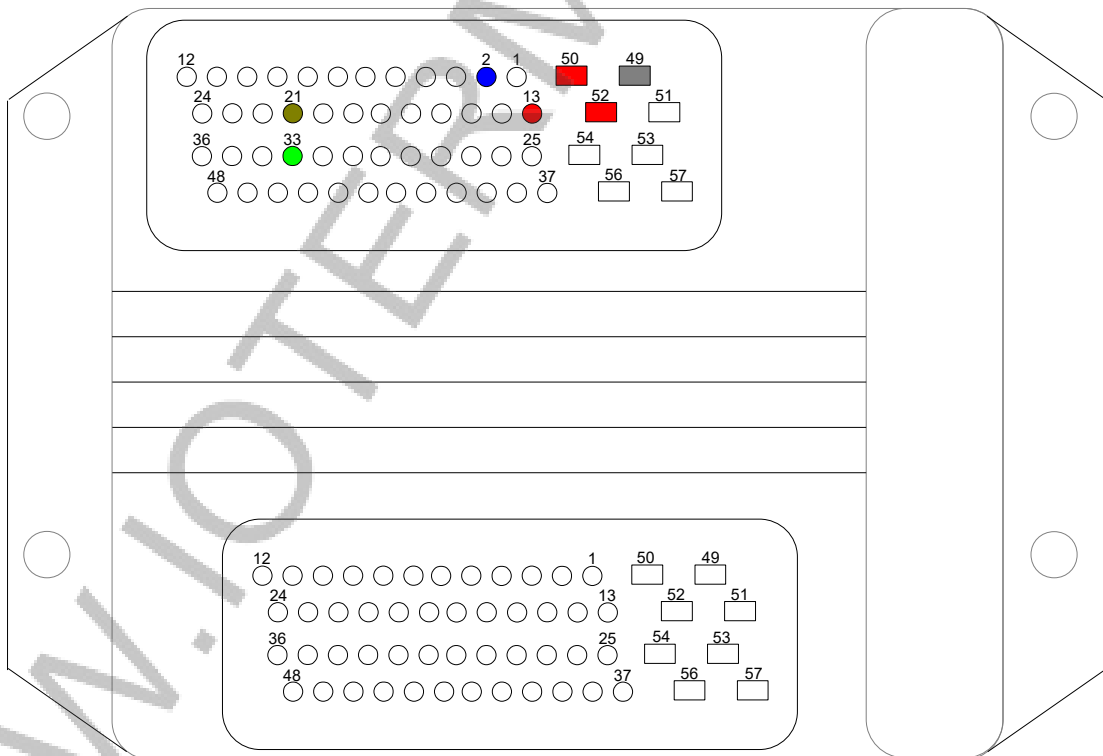

+12V	+12V IGNITION	GND	CANH	CANL	KLINE
50,52	13	49	21	33	2

SUZUKI 1.3/1.5/1.6 DENSO 64F7055,64F7058

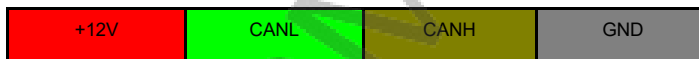
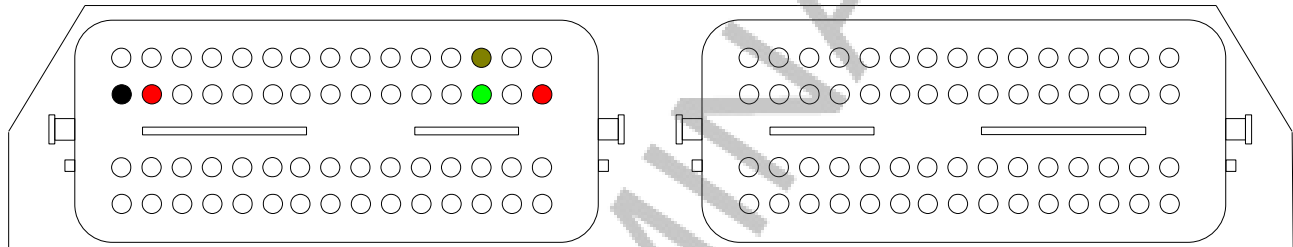

**MITSUBISHI 2.5 DID 136CV
L200/PAJERO-4D56/4M41
SUBARU FORESTER 2007 2.0D 150hp KH DENSO 64F7058**

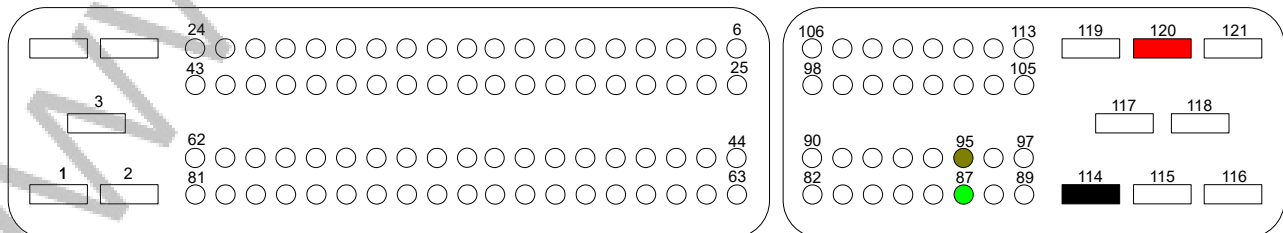

NISSAN NAVARA/PATHFINDER 2.5DCI 174CV 2005-2009

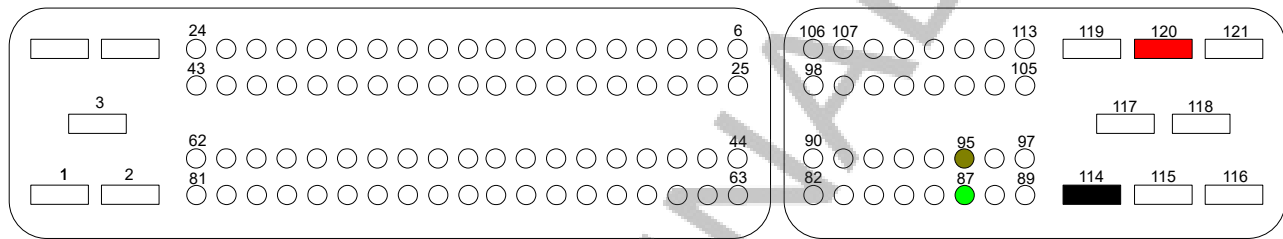

+12V	CANH	CANL	GND
120	95	87	114

Volvo V50/S40 2006-2010 140/170hp DENSO 64F7058

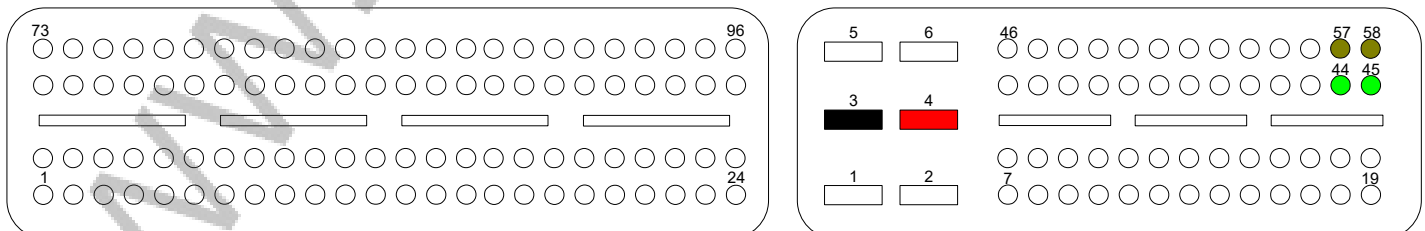

+12V	CANH	CANL	GND
4	57,58	44,45	3

Volvo V70/S60/S80 140/170hp DENSO 64F7058,64F7055

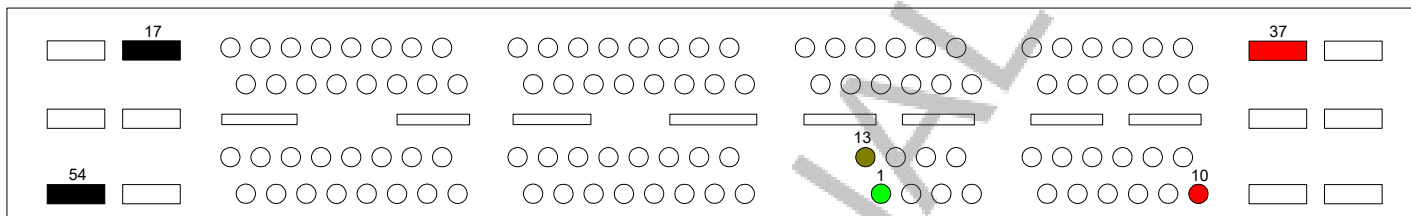

+12V	CANH	CANL	GND
10,37	13	1	54,17

MAZDA RX8 DENSO 64F7055

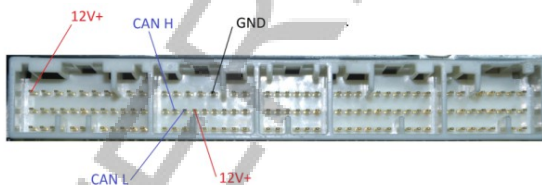

SUZUKI JIMNY 1.3 85ps DENSO 64F7055

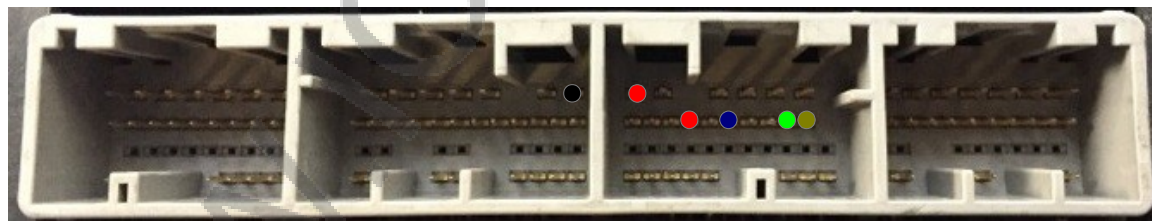

+12V	CANH	CANL	GND
------	------	------	-----

MAGNETI MARELLI IAW-9GF 1.2 8V

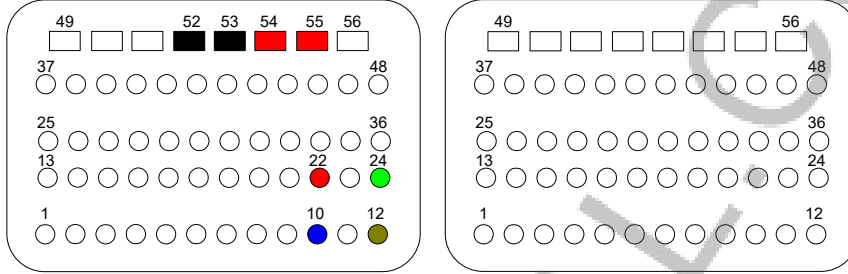

+12V	CANH	CANL	GND	KLINE
22,54,55	12	24	52,53	10

OPEL/SAAB TRIONIC 8

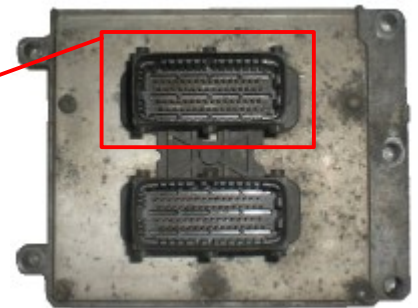
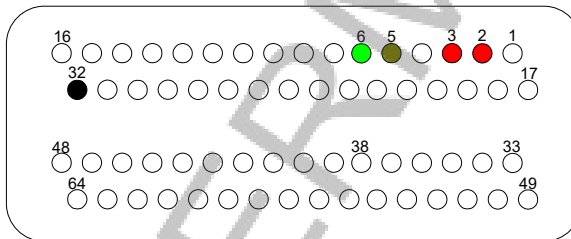

+12V	CANH	CANL	GND
2,3	5	6	32

OPEL/MAZDA/FORD BOSCH EASYTRONIC

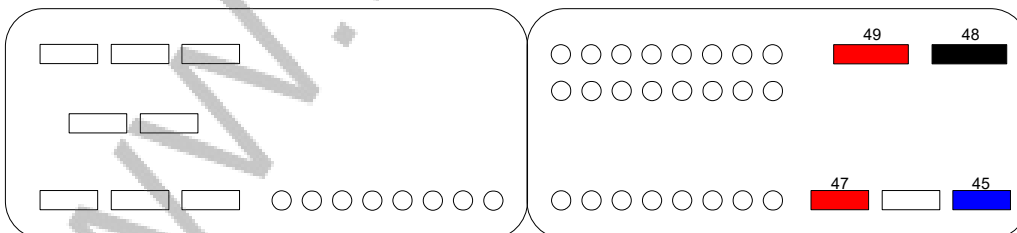

+12V	KLINE	GND
47,49	45	48

Volvo S80/XC90 4.4L V8 2007-2010 DENSO 64F7058

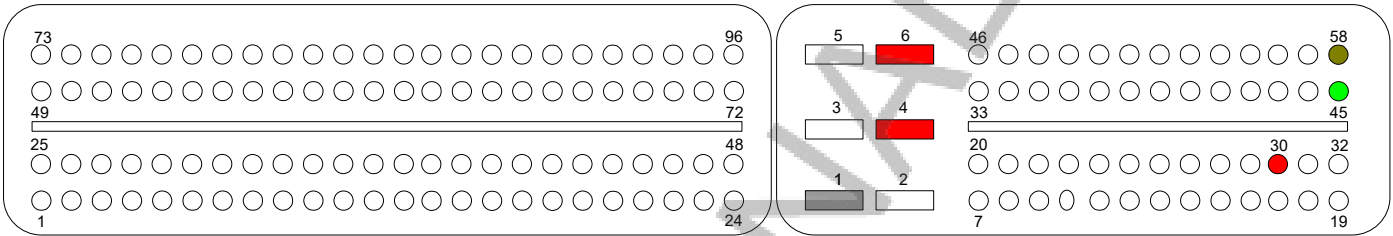

+12V	+12V IGNITION	CANH	CANL	GND
4,6	30	58	45	1

JAGUAR/LANDROVER P3.0NA / JAGUAR XF 4.2SC DENSO 64F7058

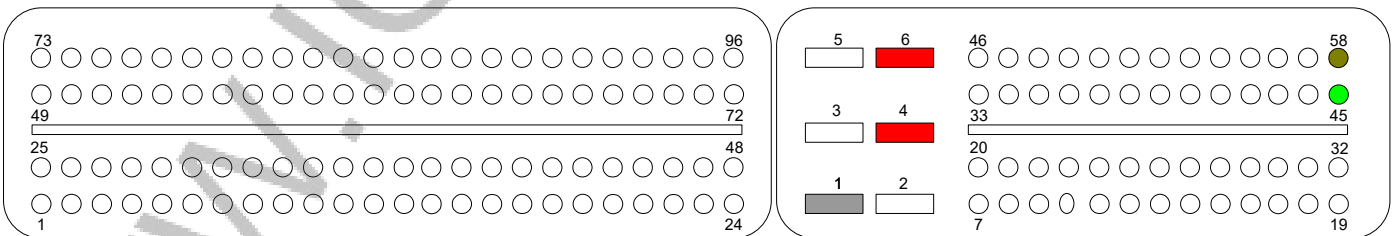

+12V	CANH	CANL	GND
4,6	58	45	1

OPEL BOSCH ME7.6.1 / ME7.6.2

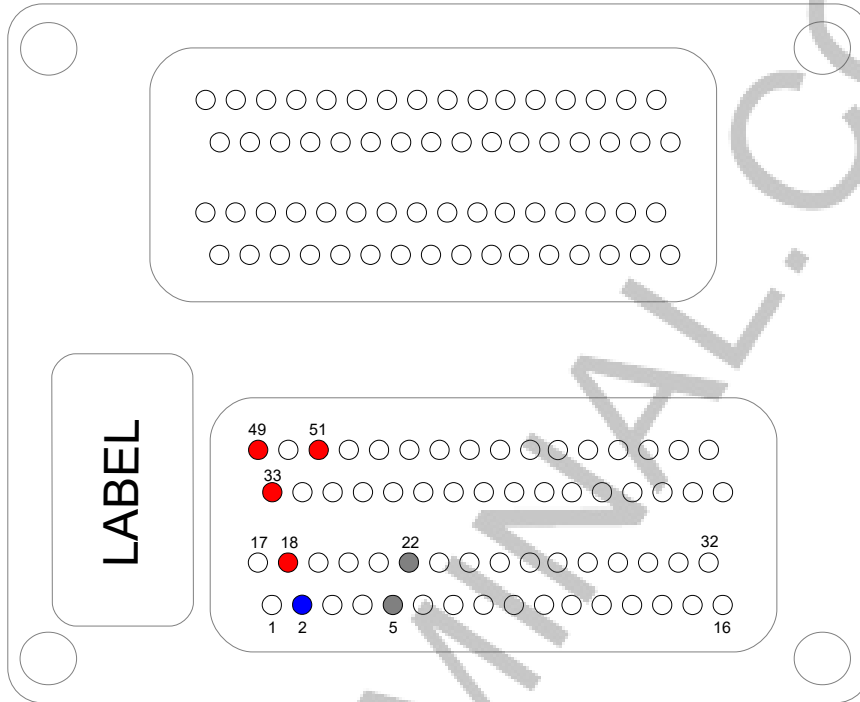

+12V	+12V IGNITION	KLINE	GND
18,33,49	51	2	5,22

OPEL BOSCH ME155/ME76H4

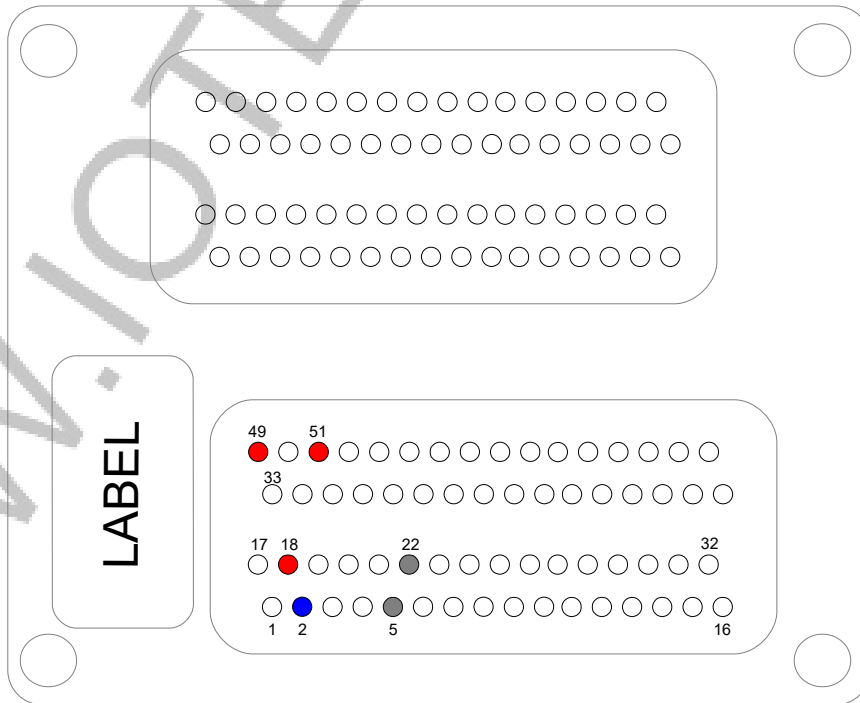

+12V	+12V IGNITION	KLINE	GND
18,49	51	2	5,22

Volvo XC90/S80 3.2L YC 2007 - 2012 DENSO 64F7058
Volvo XC60/V70/XC70/S80 3.0L T6 YF 2007 - 2012 DENSO 64F7058

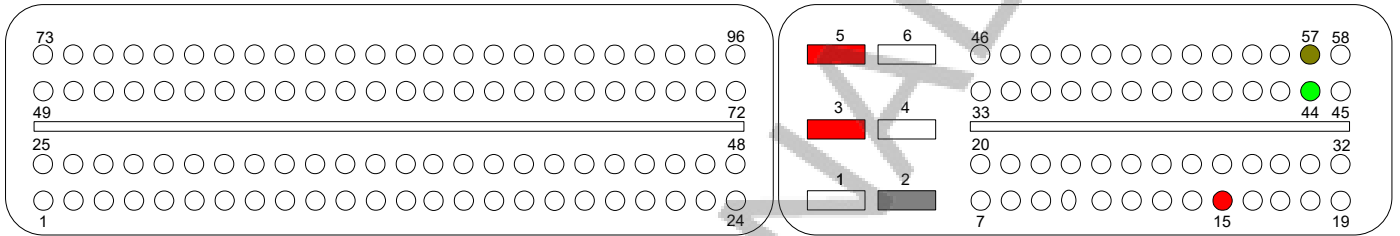

+12V	+12V IGNITION	CANH	CANL	GND
3,5	15	57	44	2

VAG BOSCH ME7.5/ME7.5-1M/ME7.1/ME71.1-1M/ME7.1.1

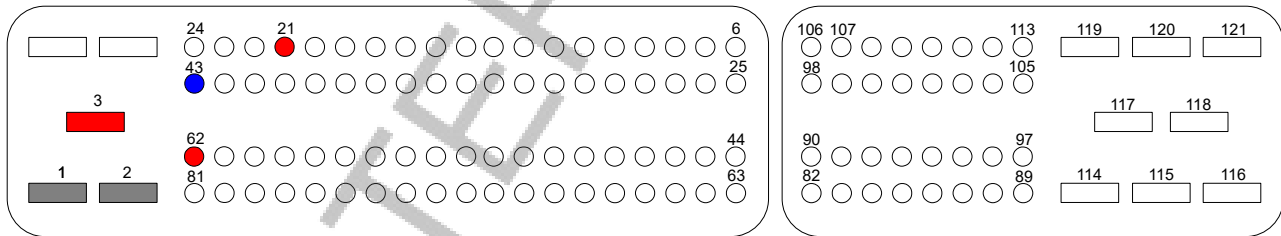

+12V	KLINE	GND
3,21,62	43	1,2

PSA BOSCH ME7.4.4

Z1

Z2

Z3

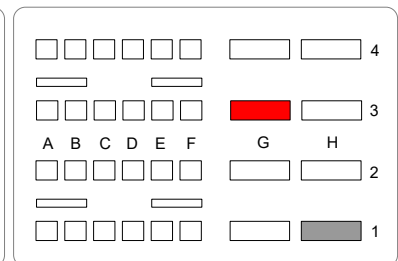
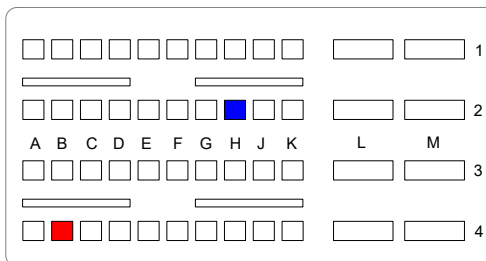
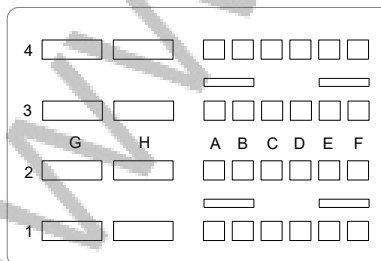

+12V	KLINE	GND
Z2-B4,Z3-G3	Z2-H2	Z3-H1

VAG BOSCH ME7.5.10

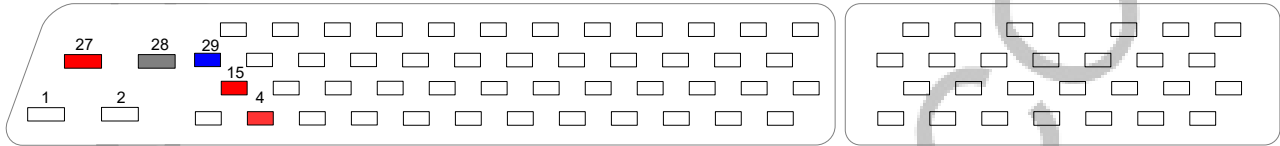

+12V	KLINE	GND
4,15,27	29	28

MAZDA 3 2007 1.6 16V DENSO ECU

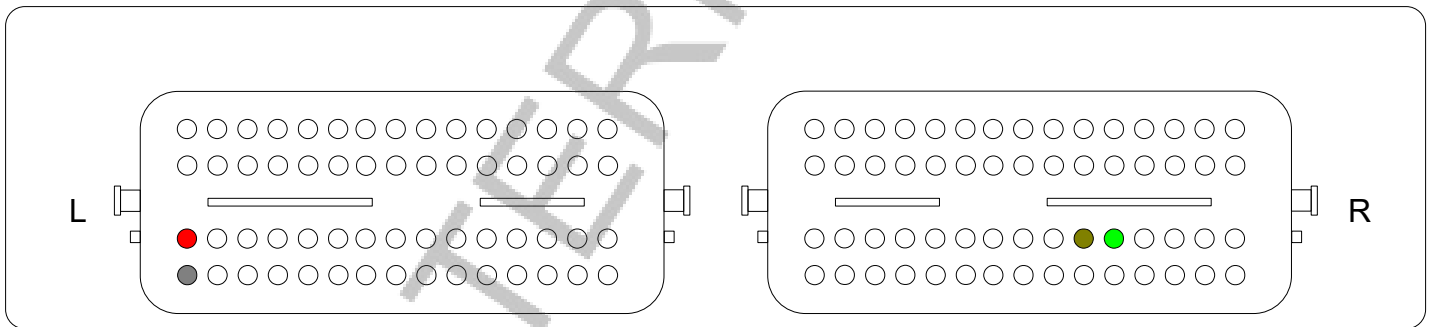

+12V	CANL	CANH	GND
------	------	------	-----

MAZDA 6 2.2TD R2AC DENSO 64F7058
SUBARU OUTBACK 2.0D NG/NN DENSO 64F7059
MITSUBISHI DELICA D5 2.2DID 4N14 DENSO 64F7059
MITSUBISHI OUTLANDER 2.2DID 4N14 DENSO 64F7059
MITSUBISHI PAJERO >2009 3.2DID 4M41 DENSO 64F7058
MITSUBISHI L200 >2009 2.5DID 4D56 DENSO
MITSUBISHI ASX >2009 1.8DID 4N13 DENSO 64F7058

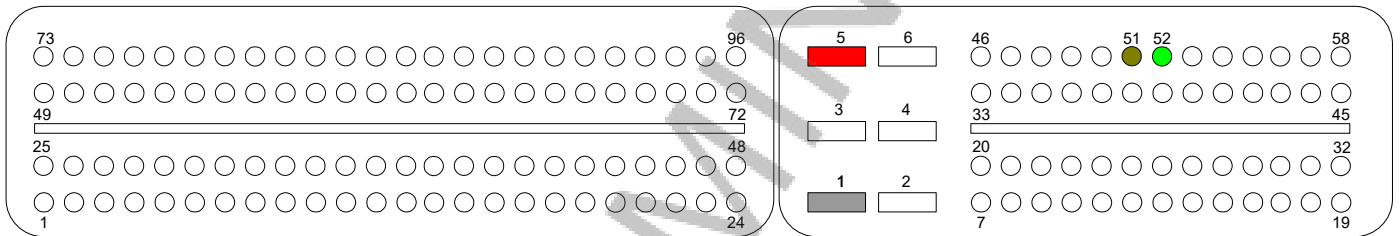

+12V	CANH	CANL	GND
5	51	52	1

FIAT BOSCH ME73H4

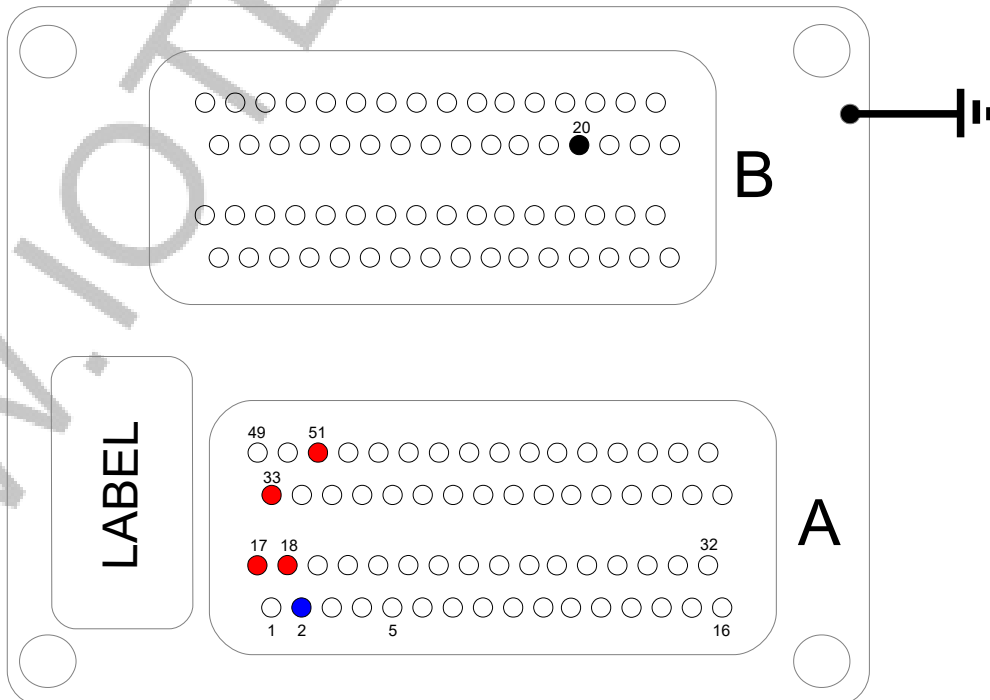

+12V	+12V IGNITION	KLINE	GND	BOOTPIN
A17,A18,A33	A51	A2	ECU CASE	B20 connect to GND

FIAT BOSCH ME731

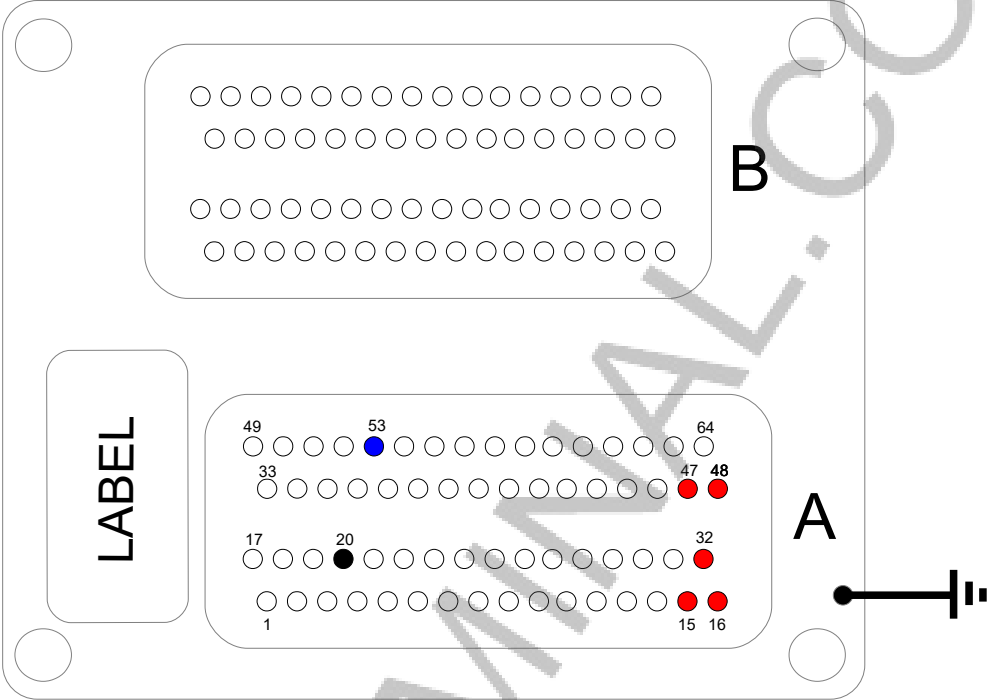

+12V	KLINE	GND	BOOTPIN
A15,A16,A32, A47,A48	A53	ECU CASE	A20 connect to GND

HONDA BOSCH ME7.9.3

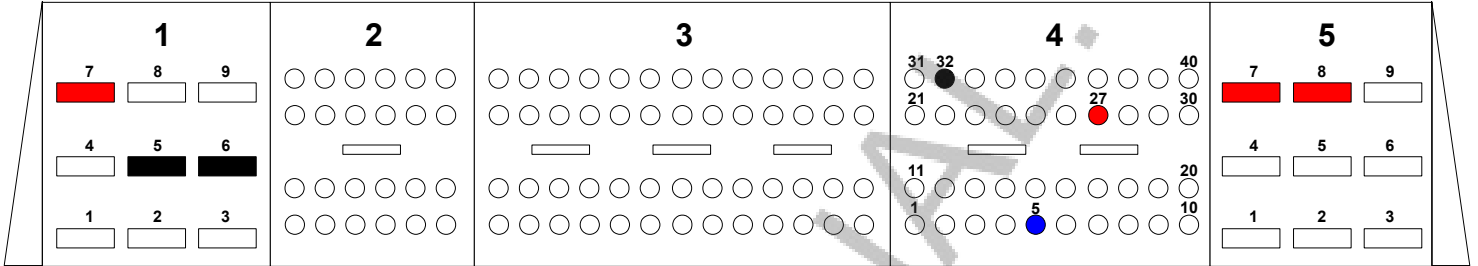

+12V	KLINE	GND	SCS
C1-7, C4-27, C5-7, C5-8	C4-5	C1-5, C1-6	C4-32 Connect to GND

TOYOTA BOSCH ME7.9.51

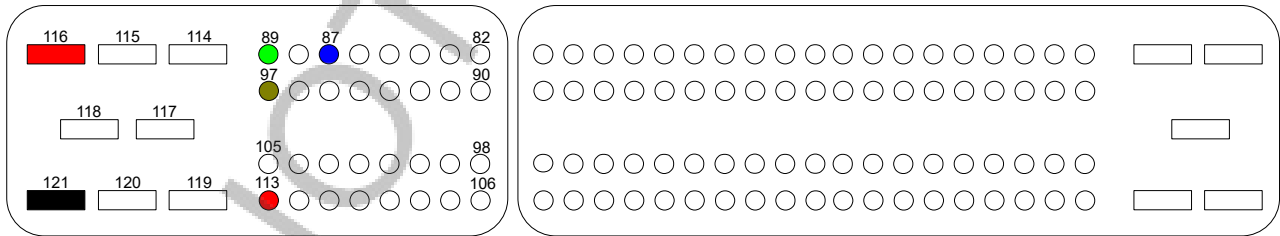

+12V	KLINE	GND	CANH	CANL
113, 116	87	121	97	89

TOYOTA BOSCH M7.9.52

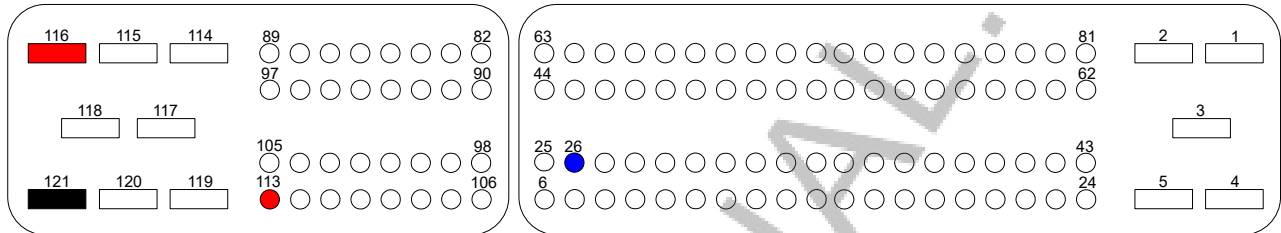

+12V	KLINE	GND
113, 116	26	121

TOYOTA BOSCH M7.9.5 / ME7.9.5

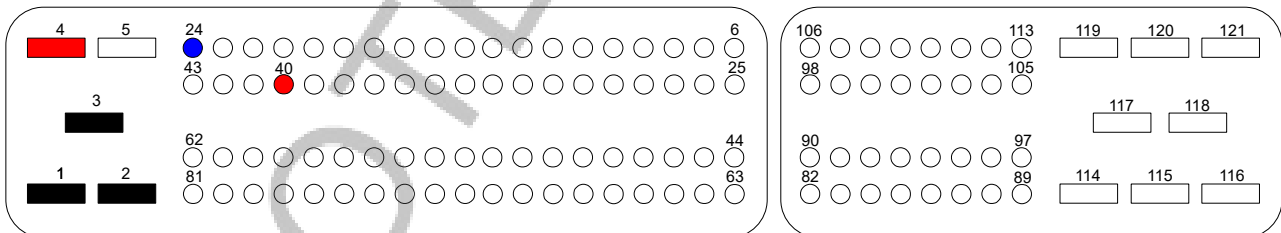

+12V	KLINE	GND
4,40	24	1,2,3

MB BOSCH EDC15C6

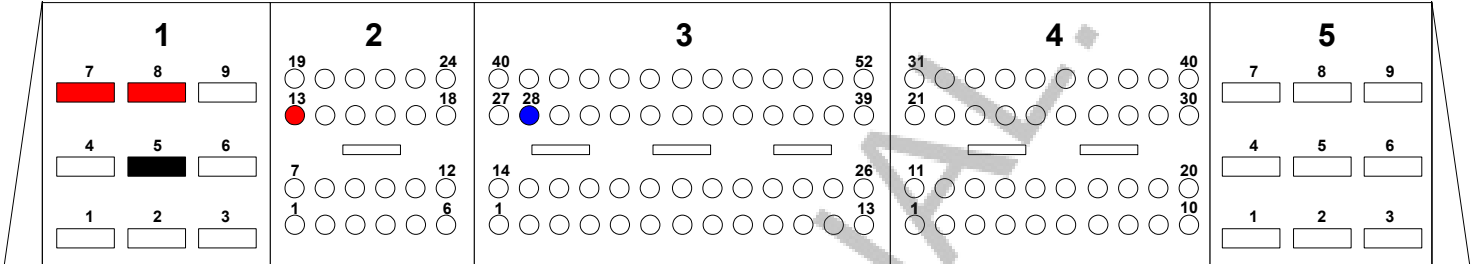

+12V	KLINE	GND
C1 - 7, C1 - 8, C2 - 13	C3 - 28	C1 - 5

PSA BOSCH EDC15C2 1 Connector

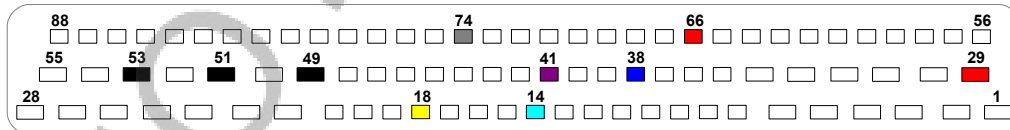
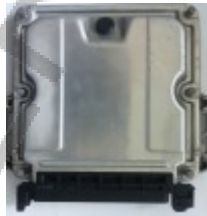

Normal or Recovery Mode Pins

+12V	KLINE	GND
29, 66	38	49, 51, 53

Special Mode Pins

GND	FX 15500-16100 Hz Square Wave 0/5V	FY 15500-16100 Hz Square Wave Inverted 0/5V	FZ 9800 - 10200 Hz Square Wave 0/5V
74	14	41	18

FLASH - 29F400BT
EEPROM - 95P08

If ecu is Virgin do not need to use Special Mode Pins. In Special Mode you need to use both Normal or Recovery Mode Pins and Special Mode Pins. This connection method bypass immobiliser. In other Modes do not use Special mode pins. How to make frequency generator read **FREQGENEDC15** manual document which u can download from www.ioterminal.com downloads section.

PSA BOSCH ME7.4.5



CPU – ST10F275
EEPROM - 95320

Z1

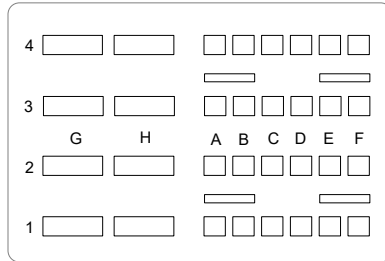

Z2

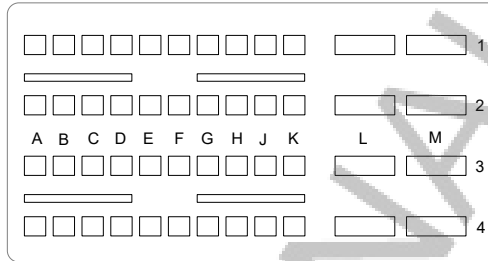

Z3

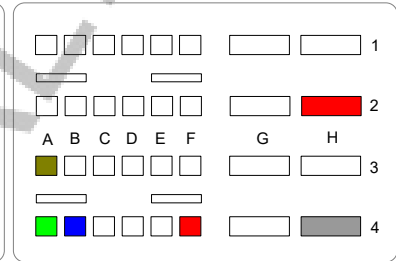

+12V	KLINE	GND	CANH	CANL
Z3 – F4, Z3 - H2	Z3 - B4	Z3-H4	Z3 - A3	Z3 - A4

MAGNETI MARELLI FIAT IAW 4AF



IAW 4AF HW204 IAW 4AF HW407
CPU – ST10F168 CPU – ST10F269
EEPROM - 95160 EEPROM - 95160

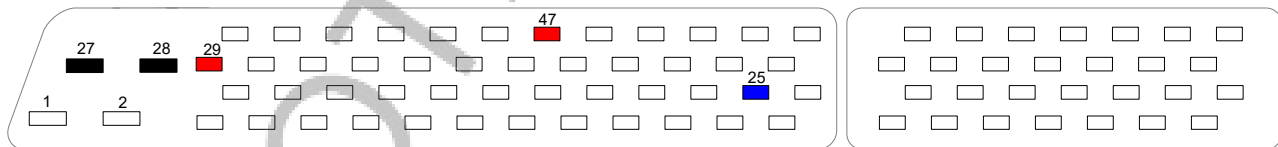

+12V	KLINE	GND
29,47	25	27,28

VAG BOSCH EDC15

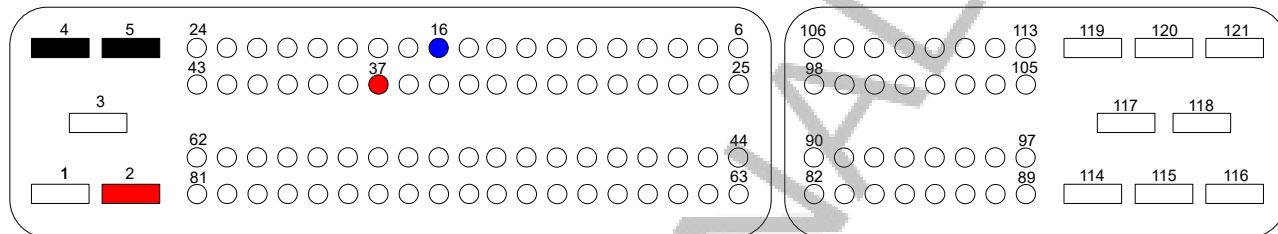

+12V	KLINE	GND
2, 37	16	4, 5

JEEP/CHRYSLER BOSCH EDC15C5

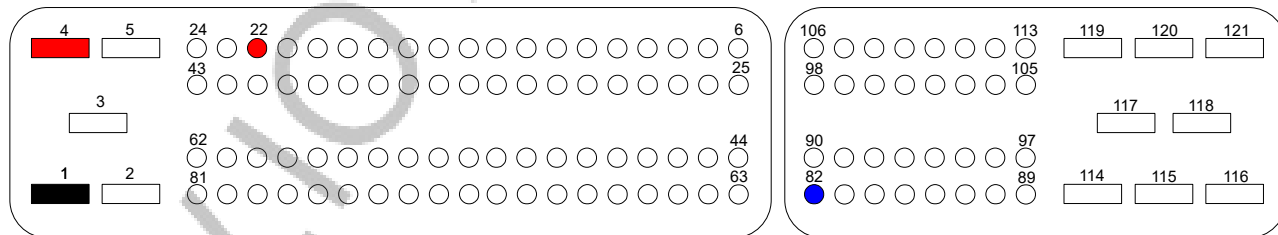

+12V	KLINE	GND
4, 22	82	1

KIA/HYUNDAY/HONDA/FIAT BOSCH EDC15C7

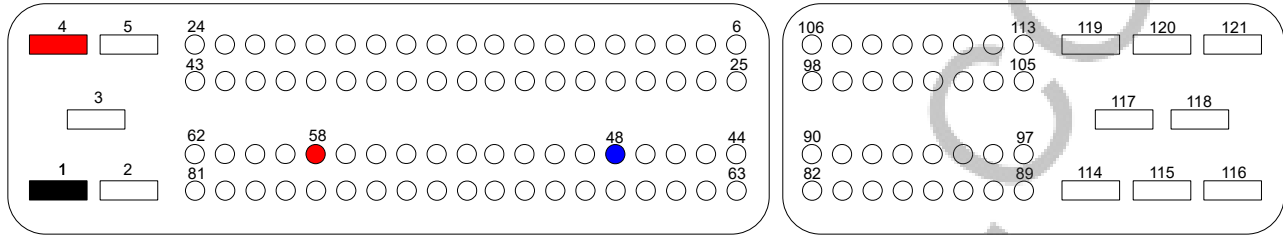

+12V	KLINE	GND
4, 58	48	1

HYUNDAY BOSCH/KEFICO ME7.9.0

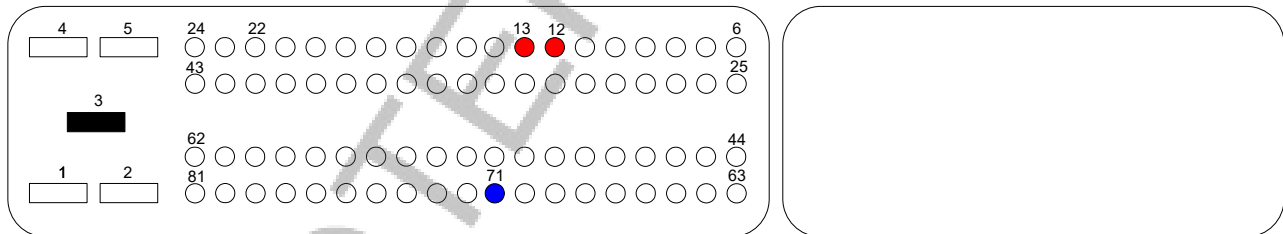

+12V	KLINE	GND
12, 13	71	3

VOLVO BOSCH EDC15C3



Z1

Z2

Z3

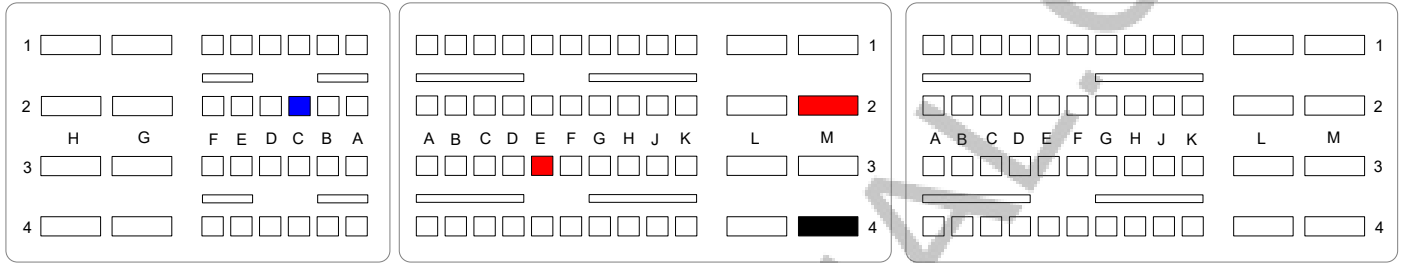

SUZUKI GRAND VITARA DENSO 64F7055,64F7058

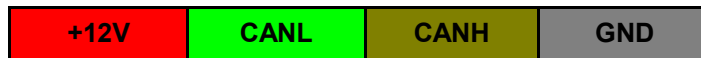
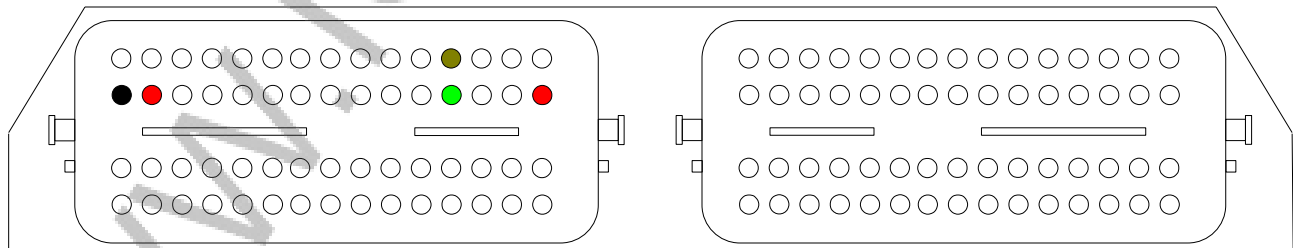

VAG BOSCH MED7.5.11

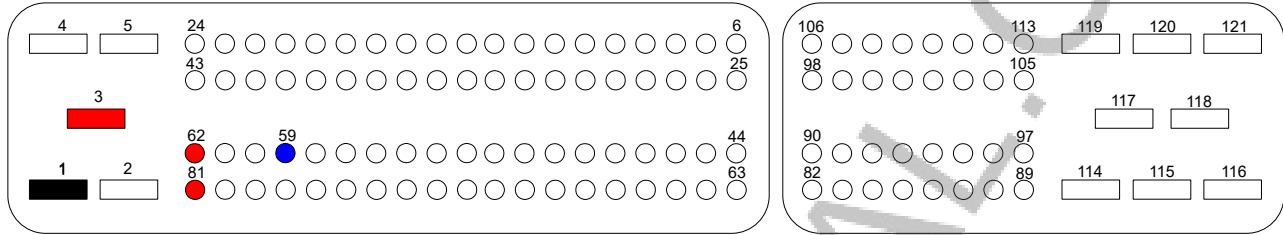

+12V	KLINE	GND
3,62,81	59	1

VOLVO BOSCH EDC15C11



FLASH - 29F400BT
 EEPROM - 95P08
 KLINE - used for recovery mode (when flash is blank)
 CAN - used in normal mode (when flash is ok)

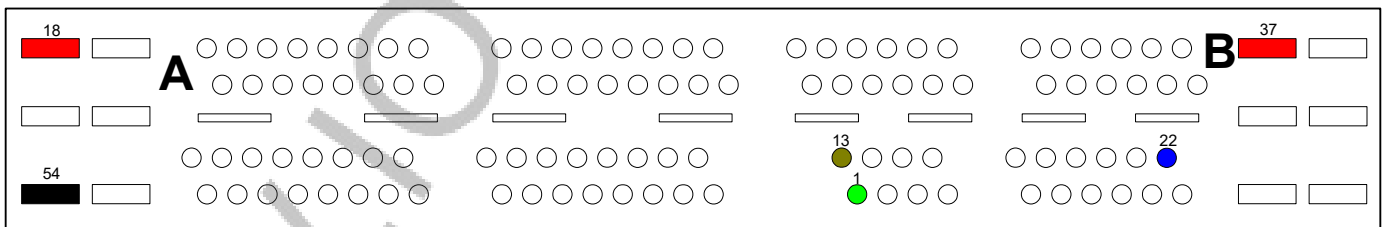

+12V	KLINE	CANH	CANL	GND
A18, B37	B22	B13	B1	A54

PSA BOSCH M7.4.4



FLASH - 29F400BB
EEPROM - 95080

Z1

Z2

Z3

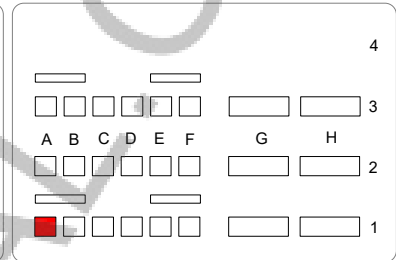
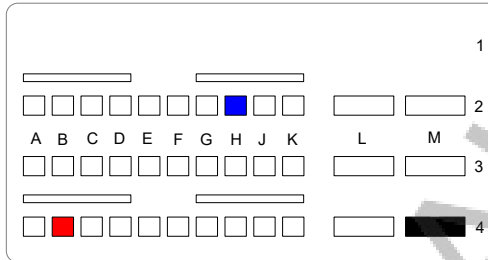
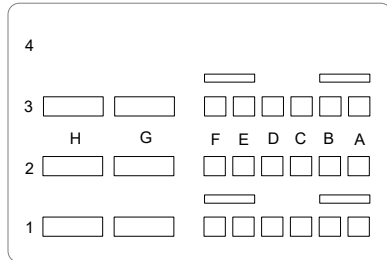

+12V	KLINE	GND
Z2-B4, Z3-A1	Z2-H2	Z2-M4

VOLVO BOSCH ME7.0



FLASH - 29F800BB
EEPROM - 95P08

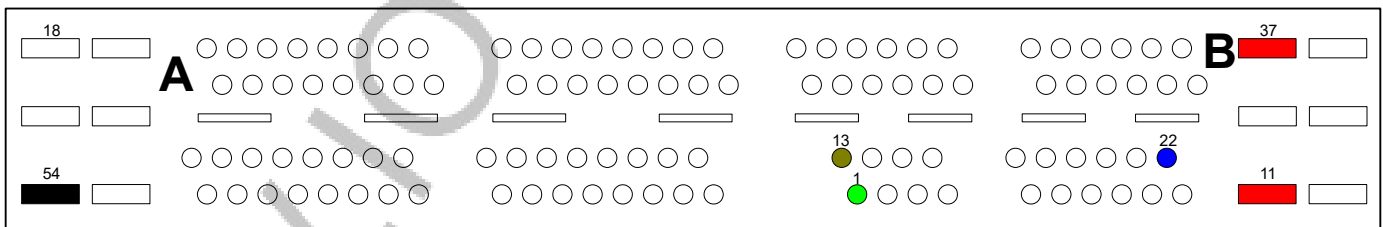

+12V	KLINE	CANH	CANL	GND
B11, B37	B22	B13	B1	A54

TOYOTA BOSCH EDC15C9



FLASH - 29F400BT
EEPROM - 95P08

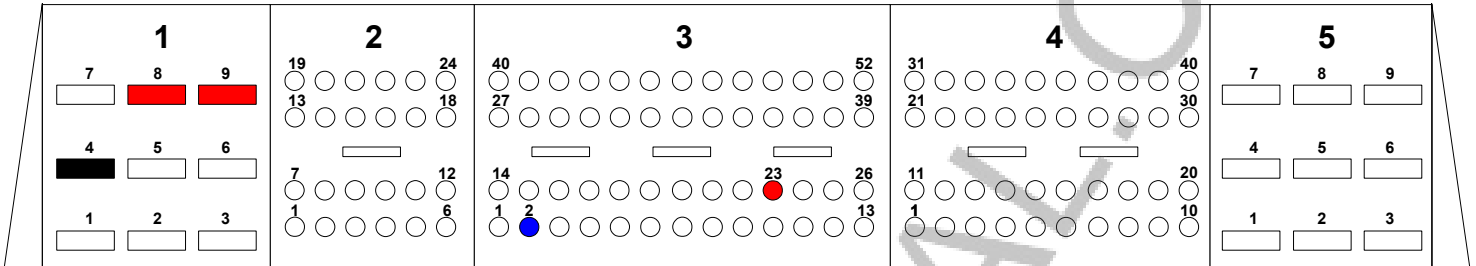

+12V	KLINE	GND
C1 - 8, C1 - 9 , C3 - 23	C3 - 2	C1 - 4

LAND ROVER RANGE ROVER AJ33 4.2 DENSO 64F7058

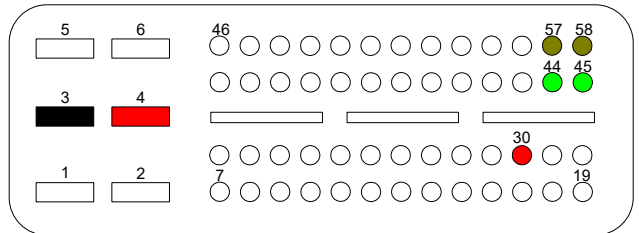
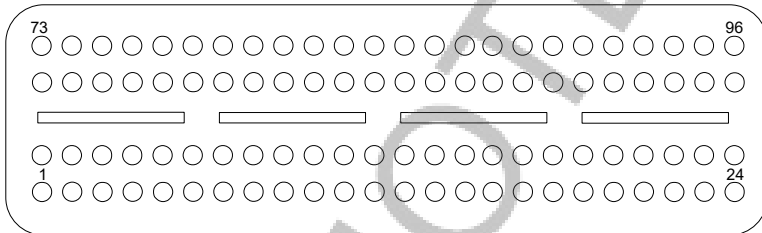

+12V	CANH	CANL	GND
4, 30	57, 58	44, 45	3

VAG BOSCH ME7.5.20

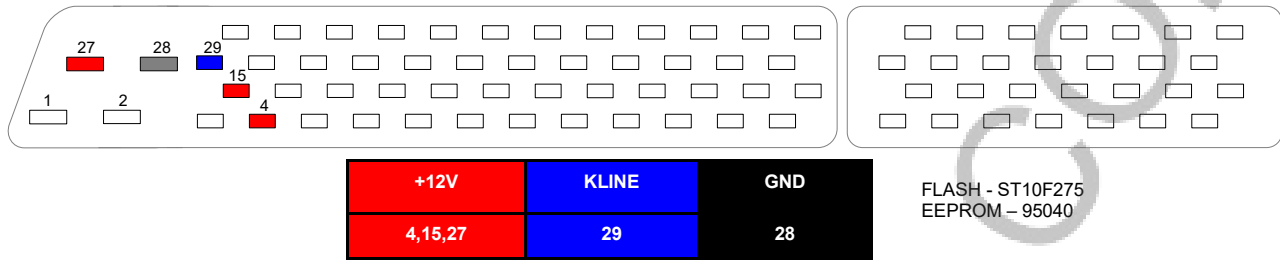

VOLVO BOSCH EDC16C31

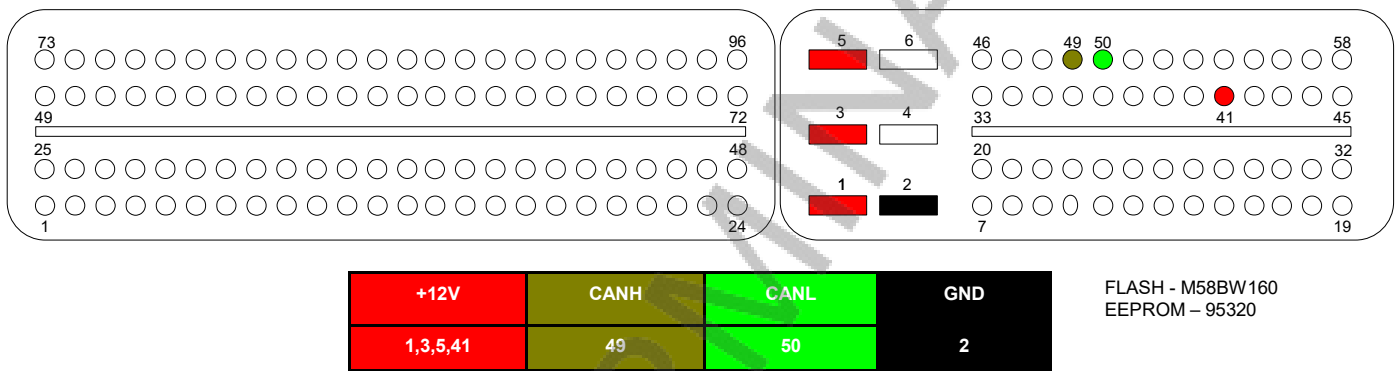

SMART BOSCH ME7.7.0

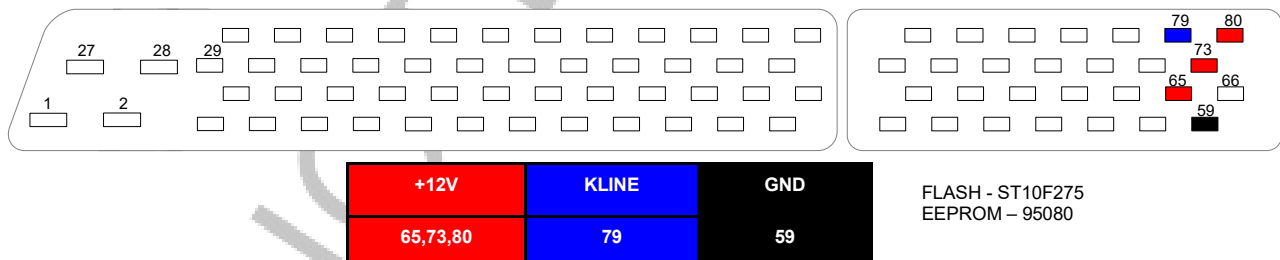

FIAT BOSCH ME7.6.3

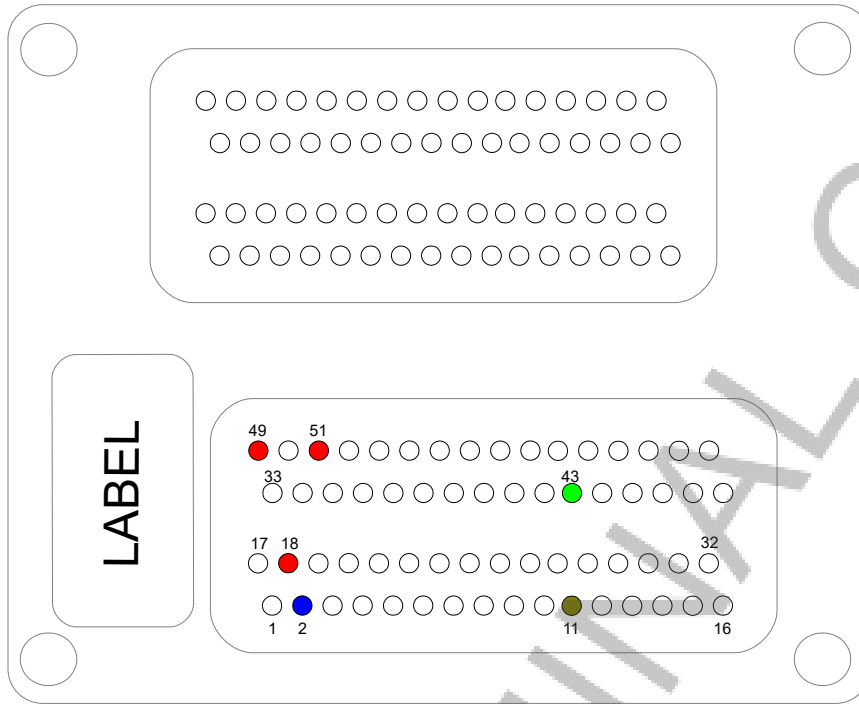

FLASH - ST10F276
EEPROM - 95080
I/O TERMINAL works by KLINE ONLY

+12V	KLINE	CANH	CANL	GND
18,49,51	2	11	43	ECU Case

FIAT/ALFA/LANCIA/ABARTH BOSCH ME7.9.10

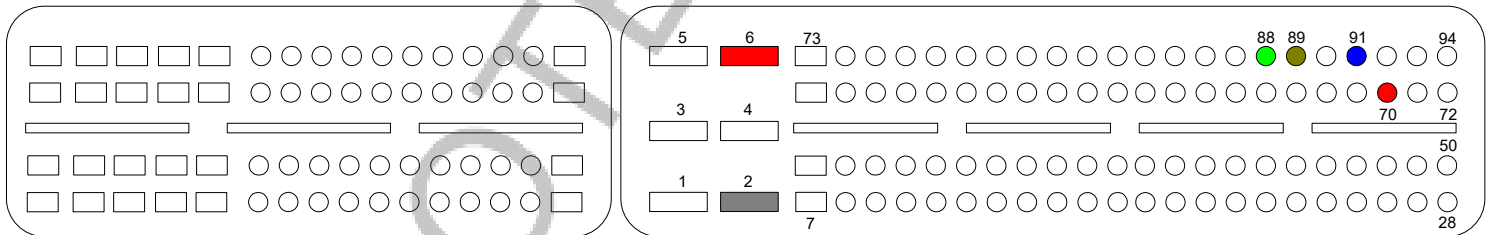

+12V	GND	CANH	CANL	KLINE
6,70	2	89	88	91

FLASH - ST10F275
EEPROM - 95160
I/O TERMINAL works by KLINE ONLY

SMART BOSCH EDG15C-5.X



FLASH - 29F400BT
EEPROM - 95P08

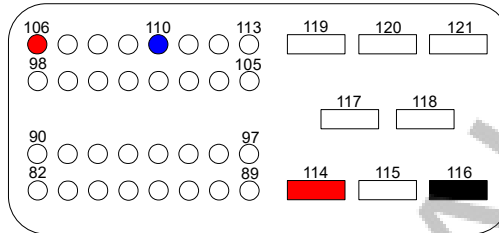

+12V	KLINE	GND
106, 114	110	116

FIAT/ALFA/LANCIA BOSCH EDC15C7 SPECIAL

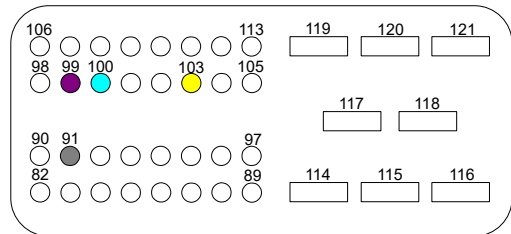
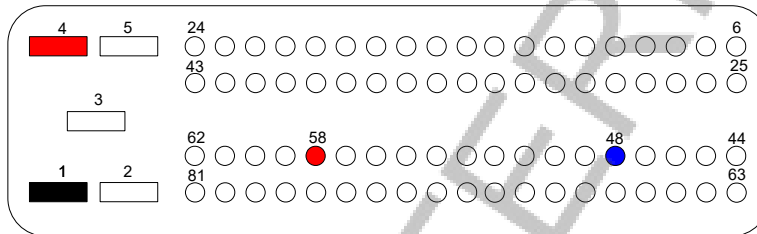

Normal or Recovery Mode Pins

+12V	KLINE	GND
4, 58	48	1

Special Mode Pins

GND	FX 15500-16100 Hz Square Wave 0/5V	FY 15500-16100 Hz Square Wave Inverted 0/5V	FZ 9800 - 10200 Hz Square Wave 0/5V
91	100	99	103

FLASH - 29F400BT
EEPROM - 95P08

If ecu is Virgin do not need to use Special Mode Pins. In Special Mode you need to use both Normal or Recovery Mode Pins and Special Mode Pins. This connection method bypass immobiliser. In other Modes do not use Special mode pins. How to make frequency generator read **FREQGENEDC15** manual document which u can download from www.ioterminal.com downloads section.

PSA BOSCH EDC15C2 3 Connectors SPECIAL

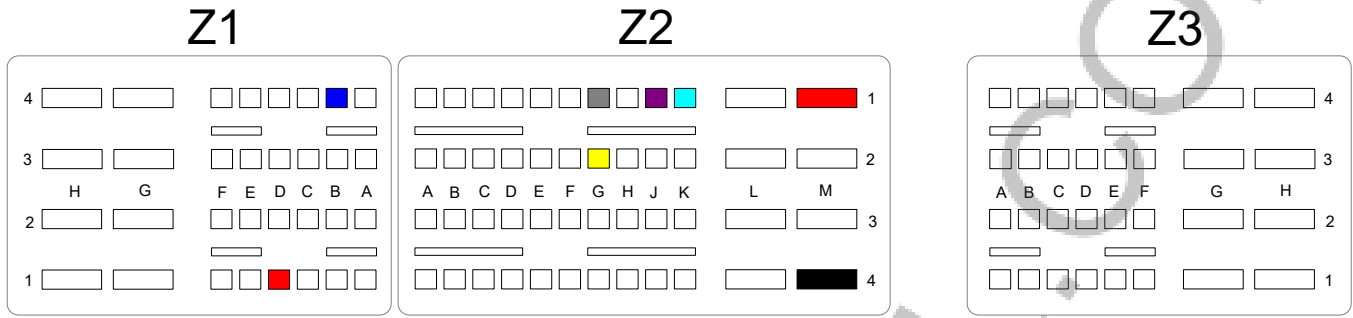

Normal or Recovery Mode Pins

+12V	KLINE	GND
Z1 - D1, Z2 - M1	Z1 - B4	Z2 - M4

FLASH - 29F400BT
EEPROM - 95P08

If ecu is Virgin do not need to use Special Mode Pins. In Special Mode you need to use both Normal or Recovery Mode Pins and Special Mode Pins. This connection method bypass immobiliser. In other Modes do not use Special mode pins. How to make frequency generator read **FREQGENEDC15** manual document which u can download from www.ioterminal.com downloads section.

Special Mode Pins

GND	FX 15500-16100 Hz Square Wave 0/5V	FY 15500-16100 Hz Square Wave Inverted 0/5V	FZ 9800 - 10200 Hz Square Wave 0/5V
Z2 - G1	Z2 - K1	Z2 - J1	Z2 - G2

BMW BOSCH EDC15C4 SPECIAL LAND ROVER EDC15C4 SPECIAL

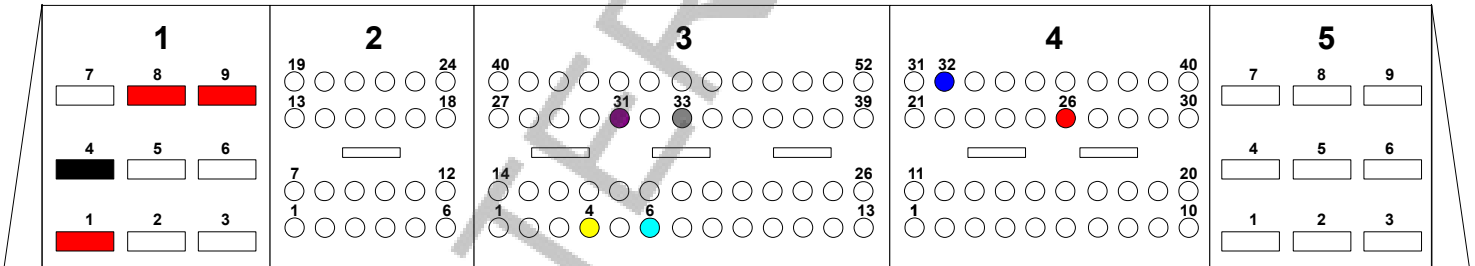

Normal or Recovery Mode Pins

+12V	KLINE	GND
1 - 1,8,9 4 - 26	4 - 32	1 - 4

FLASH - 29F400BT
EEPROM - 95P08

If ecu is Virgin do not need to use Special Mode Pins. In Special Mode you need to use both Normal or Recovery Mode Pins and Special Mode Pins. This connection method bypass immobiliser. In other Modes do not use Special mode pins. How to make frequency generator read **FREQGENEDC15** manual document which u can download from www.ioterminal.com downloads section.

Special Mode Pins

GND	FX 15500-16100 Hz Square Wave 0/5V	FY 15500-16100 Hz Square Wave Inverted 0/5V	FZ 9800 - 10200 Hz Square Wave 0/5V
3 - 33	3 - 6	3 - 31	3 - 4

VOLVO BOSCH EDC16C34



FLASH - M58BW160
EEPROM - 95160

Z1

Z2

Z3

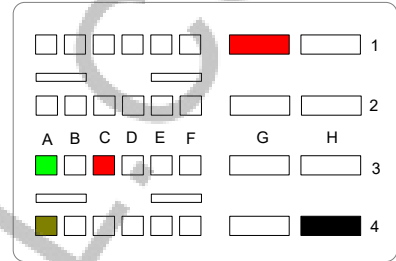
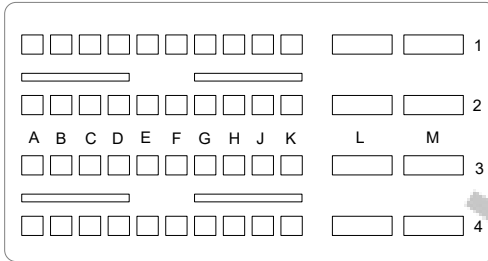
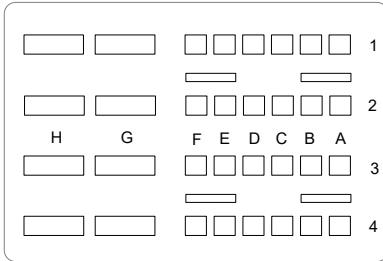

+12V	CANH	CANL	GND
Z3 - G1, Z3 - C3	Z3 - A4	Z3 - A3	Z3 - H4

VOLVO SIEMENS EMS2000



S108xxx - FLASH - 29F200BB
S1109xx - FLASH - 29F400BB

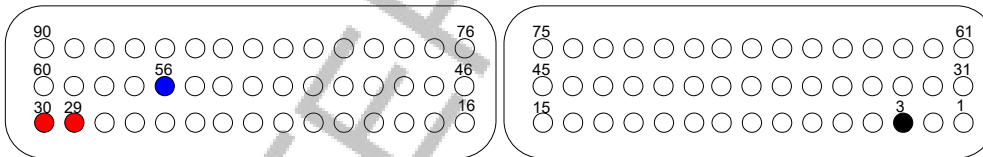

+12V	KLINE	GND
29,30	56	3

GM ME7.9.9 Chevrolet Captiva/Opel Antara 2.4L

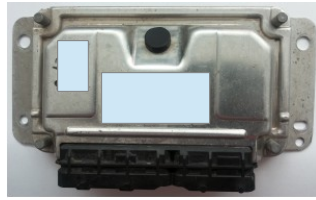

FLASH - ST10F275
 EEPROM - 95080
 I/O TERMINAL works by KLINE ONLY

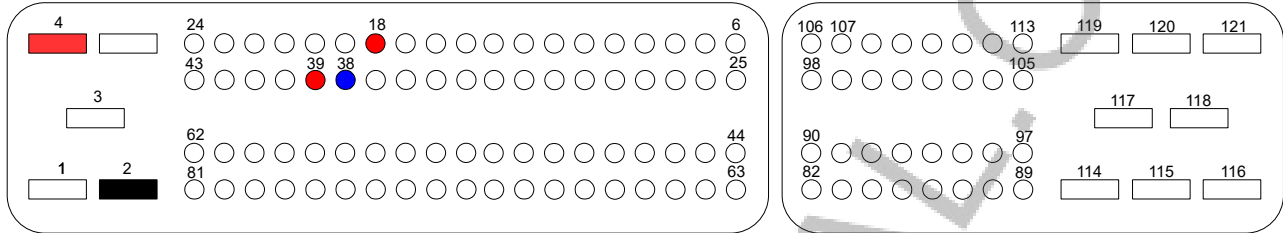

+12V	KLINE	GND
4,18,39	38	2

WWW.IOTERMINAL.COM

VOLVO BOSCH EDC16C34



FLASH - M58BW160
EEPROM - 95160

Z1

Z2

Z3

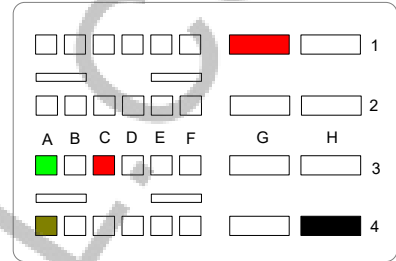
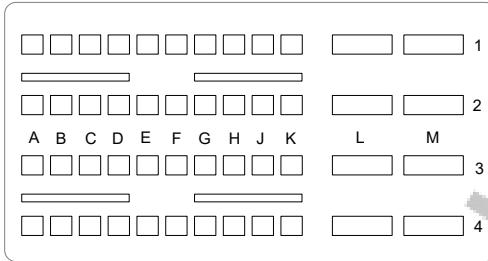
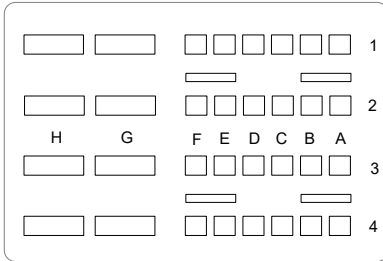

+12V	CANH	CANL	GND
Z3 - G1, Z3 - C3	Z3 - A4	Z3 - A3	Z3 - H4

VOLVO SIEMENS EMS2000



S108xxx - FLASH - 29F200BB
S1109xx - FLASH - 29F400BB

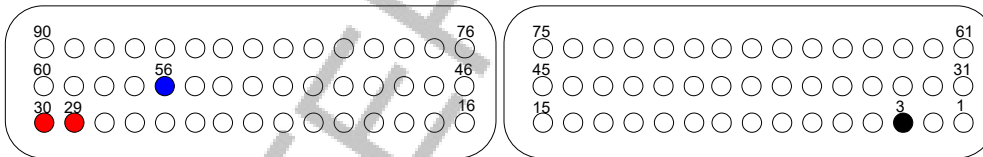

+12V	KLINE	GND
29,30	56	3

VOLVO BOSCH ME9.0



FLASH - M58BW160
EEPROM - 95080

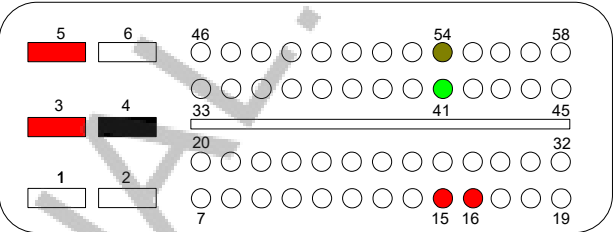
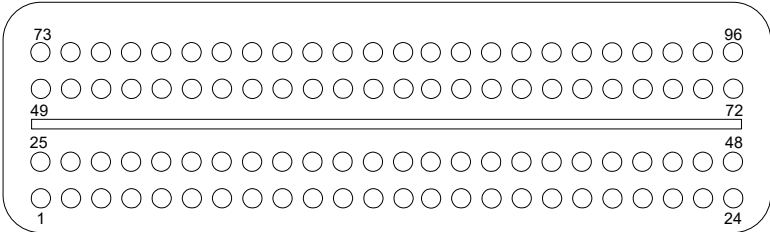

+12V	CANH	CANL	GND
3,5,15,16	54	41	4

WWW.IOTERMINAL.COM

Jaguar S-Type 4.2 V8 V8SC DENSO 64F7058

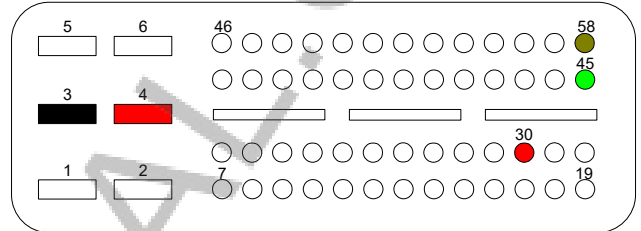
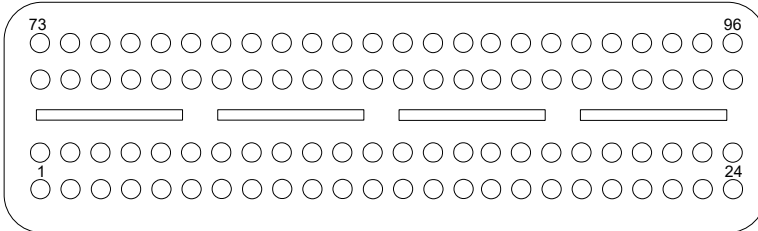

+12V	CANH	CANL	GND
4, 30	58	45	3

MAGNETI MARELLI MJD9 1.3 FIAT MJD 9DF



Microcontroller SPC5644
EEPROM – 95128

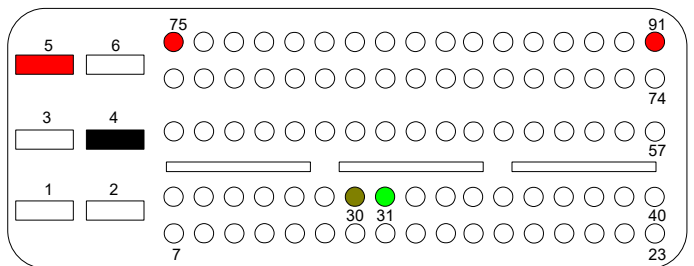
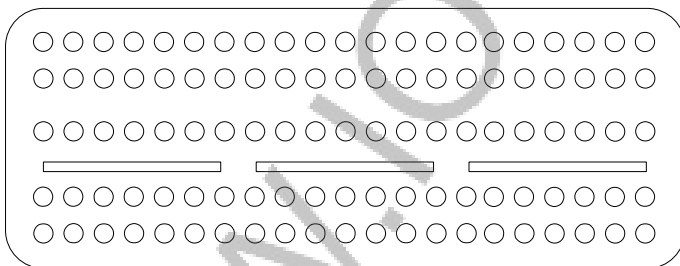

+12V	CANH	CANL	GND
5,75,91	30	31	4

BMW MINI/ROVER Siemens EMS2

BMW MINI Siemens EMS5150

FLASH - 29F400BB

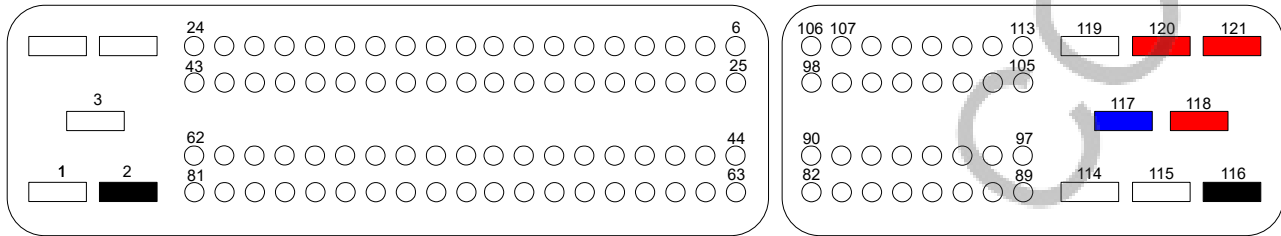

+12V	KLINE	GND
118,120,121	117	2,116

BMW MINI/ROVER Siemens EMS

GM Siemens/Continental D42

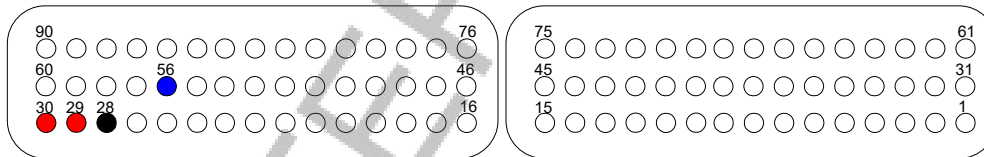

+12V	KLINE	GND
29,30	56	28

FORD SIEMENS/CONTINENTAL EMS2101, EMS2102, EMS2103



FLASH - 29F400BB, 29F800BB
EEPROM - 93C86

Z1

Z2

Z3

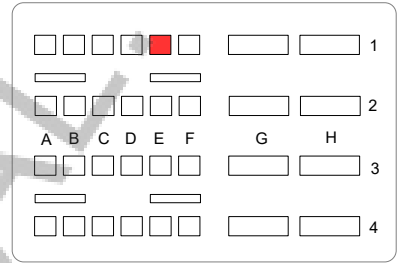
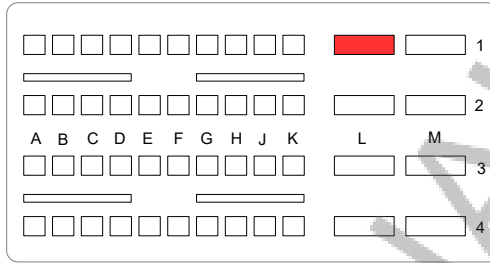
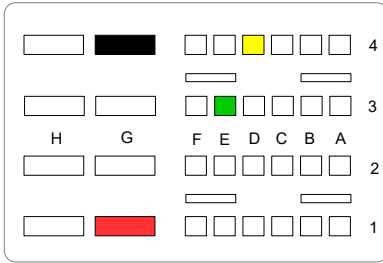

+12V	CANH	CANL	GND
Z1 - G1, Z2 - L1, Z3 - E1	Z1 - D4	Z1 - E3	Z1 - G4

WWW.IOTERMINAL.COM

FIAT IAW 7GF WIRING DIAGRAMS

MPC5534+95640

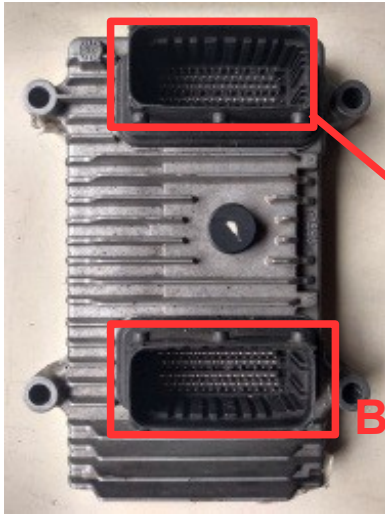

A

I/O TERMINAL with this kind of ecu works in bench mode by CAN1 only .
For this you will need special adapter BEMODEADP1. Adapter schematic you can find on www.ioterminal.com in documents section (BEMODEADP1.pdf)

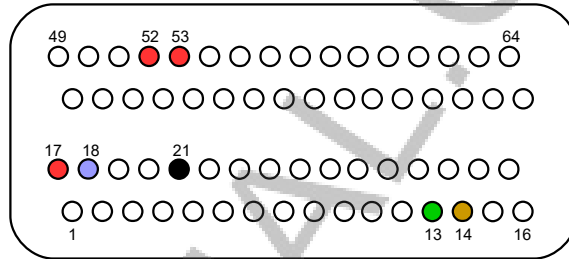

+12V	GND	CANH	CANL	KLINE
A-17 A-52 A-53	A-21	A-14	A-13	A-18

WWW.IOTERMINAL.COM

SUZUKI GRAND VITARA 2.4 DENSO 64F7058

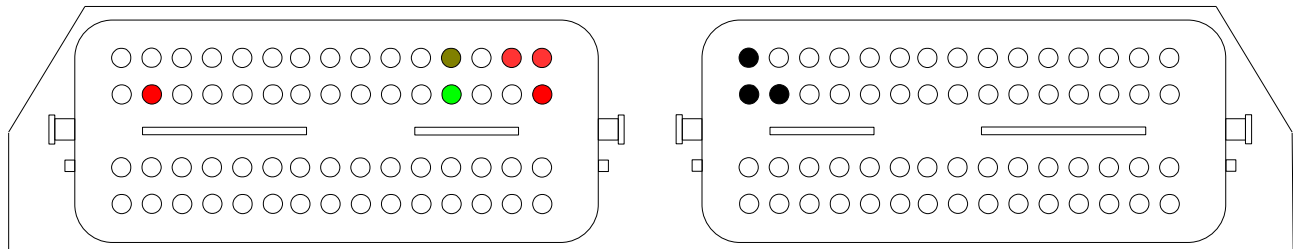

VAG IAW 9GV WIRING DIAGRAMS

MPC5634+95320



I/O TERMINAL with this kind of ecu works in bench mode by CAN1 only .
For this you will need special adapter BEMODEADP1. Adapter schematic
you can find on www.ioterminal.com in documents section (BEMODEADP1.pdf)

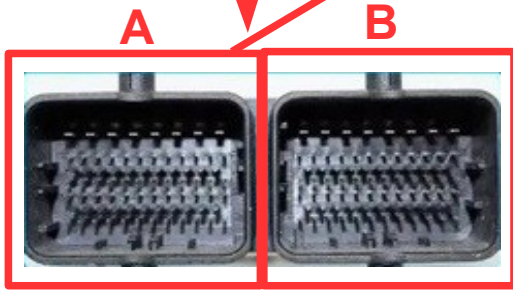
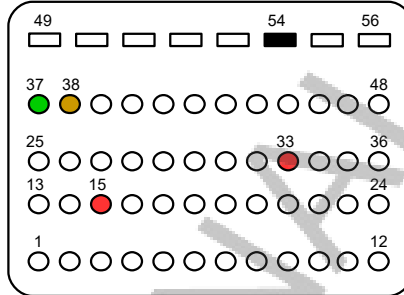

+12V	GND	CANH	CANL
A-15 A-33	A-54	A-38	A-37

FIAT IAW 10GF WIRING DIAGRAMS

MPC5642+95640



I/O TERMINAL with this kind of ecu works in bench mode by CAN1 only .
For this you will need special adapter BEMODEADP1. Adapter schematic
you can find on www.ioterminal.com in documents section (BEMODEADP1.pdf)

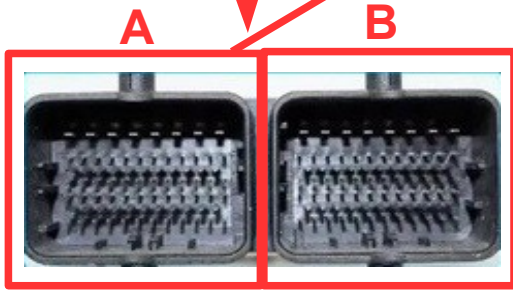
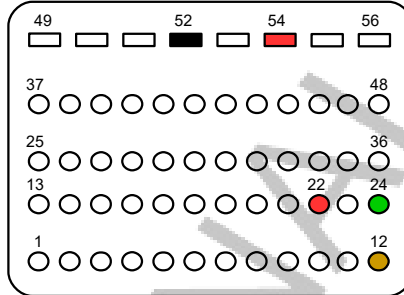

+12V	GND	CANH	CANL
A-22 A-54	A-52	A-12	A-24

FIAT IAW 9GF WIRING DIAGRAMS

MPC5642+95640



I/O TERMINAL with this kind of ecu works in bench mode by CAN1 only .
 For this you will need special adapter BEMODEADP1. Adapter schematic
 you can find on www.ioterminal.com in documents section (BEMODEADP1.pdf)

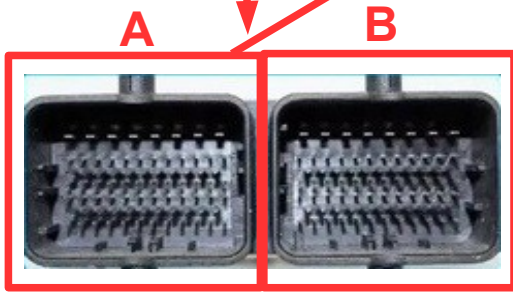
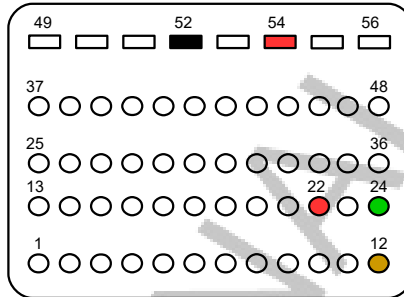

+12V	GND	CANH	CANL
A-22 A-54	A-52	A-12	A-24