



PS80

Diagnosis System

User Manual

Declaration

1. This manual is designed for the usage of PS80, applying to PS80 automotive diagnosis platform.

No part of this manual can be reproduced, stored in a retrieval system or transmitted, in any form or by any means (electronic, mechanical, photocopying, recording, or otherwise), without the prior written permission of Xtool.

2. Use the device only as described in this manual. The user will be responsible solely for the after-effects of violating the laws and regulations caused by using the product or its data information; in this case Xtool will not bear any legal responsibility.

3. Xtool shall not be liable for any incidental or consequential damages or for any economic consequential damages arising from the accidents of individual users and the third parties, misuse or abuse of the device, unauthorized change or repair of the device, or the failure made by the user not to use the product according to the manual.

4. All information, specifications and illustrations in this manual are based on the latest configurations and functions available at the time of printing. Xtool reserves the right to make changes at any time without notice.

5.  is the registered trademark of SHENZHEN XTOOLTECH CO.,LTD.

6. In countries that the trademarks, service marks, domain names, logos and the name of the company are not registered, Xtool claims that it still reserves the ownership of the unregistered trademarks, service marks, domain names, logos and the company name. All other marks for the other products and the company's name mentioned in the manual still belong to the original registered company.

You may not use the trademarks, service marks, domain names, logos and company name of Xtool or other companies mentioned without written permission from the trademark holder.

7. Please visit www.xtooltech.com for more information on the PS80.

8. Xtool reserves the right for the final interpretation of this manual content.

Xtool PS80 User Manual Instructions

Please read this user manual carefully before using the scanner.

When reading the manual, please pay special attention to the words "Note", "Caution" or "Warning", read them carefully for appropriate operation.

Xtool PS80 Diagnosis System Main Unit Maintenance

Avoid shaking or dismantling the unit as it may damage the internal components.

Do not use hard or sharp objects to touch the LCD screen; do not use excessive force; do not expose the screen to strong sunlight for a long period.

Caution: keep it away from water, moisture, high temperature or very low temperature.

If necessary, calibrate the screen before testing to ensure the accuracy of LCD performance.

Keep the main unit away from strong magnetic fields.

Operation Instructions

For safe operation please follow the instructions below:

Keep the scanner away from heat or fumes when using it.

If the vehicle battery contains acid, please keep your hands and skin or fire sources away from the battery during testing.

Exhaust gas of vehicle contains harmful chemicals, please ensure adequate ventilation.

Do not touch the cooling system components or exhaust manifolds when engine is running due to the high temperatures reached.

Make sure the car is securely parked, Neutral is selected or the selector is at P or N position to prevent the vehicle from moving when engine starts.

Make sure the (DLC) diagnostic link connector is functioning properly before starting the test to avoid damage to the Diagnostic Computer.

Do not switch off the power or unplug the connectors during testing, otherwise you may damage the ECU and/or the Diagnostic Computer.

Contents

CHAPTER I About PS80	1
1. Appearance	1
1.1. Front View.....	1
1.2. Back View.....	1
2. Layout of PS80 Tablet	2
2.1. Top View of PS80 Tablet.....	2
2.2. Side View of PS80 Tablet.....	2
3. PS80 Technical Parameters.....	2
CHAPTER II How to Use PS80	3
1. PS80 Activation	3
2. PS80 Main Interface and Functional Buttons Descriptions	4
2.1. Main Interface.....	4
2.2. Sub-menu and Functional Buttons	5
2.3. Toolbar Functional Buttons	5
3. Vehicle Connection Diagnosis	6
3.1. Vehicle Connection Test	6
3.2. Precautions Before Use	6
4. Diagnosis	7
4.1. Menu Options	7
4.2. Test Functions	8
4.3. Read ECU	10
4.4. Read DTCs.....	10
4.5. Clear DTCs	11
4.6. Read Live Data.....	12
4.7. Special Functions	15
4.8. Actuating Components Test	15
5. Settings.....	16
6. XCloud	17
7. Update.....	17
8. Report.....	18
9. Remote	20
CHAPTER III Location of Diagnostic Link Connectors on Different Vehicle Models ..	21
1. Diagnostic Link Connectors Locations of Various Vehicle Models.....	21
2. Location Diagram of Vehicle Diagnostic Link Connectors	25
3. Diagnostic Link Connectors Terminal Definition and Communication Protocols	25

CHAPTER I About PS80

1. Appearance

1.1. Front View



1.2. Back View



2. Layout of PS80 Tablet

2.1. Top View of PS80 Tablet

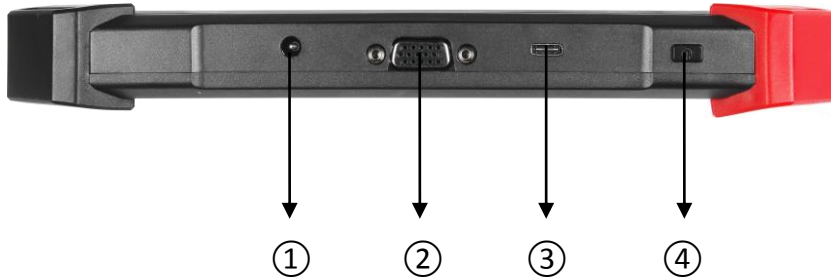

- ① Charging port: Battery charging
- ② DB15 Port: Supports wired connection with car by the cable
- ③ USB Type C Port: Compatible with HDMI TV port, and support for quick charging
- ④ Power Button: Power on or power off

2.2. Side View of PS80 Tablet

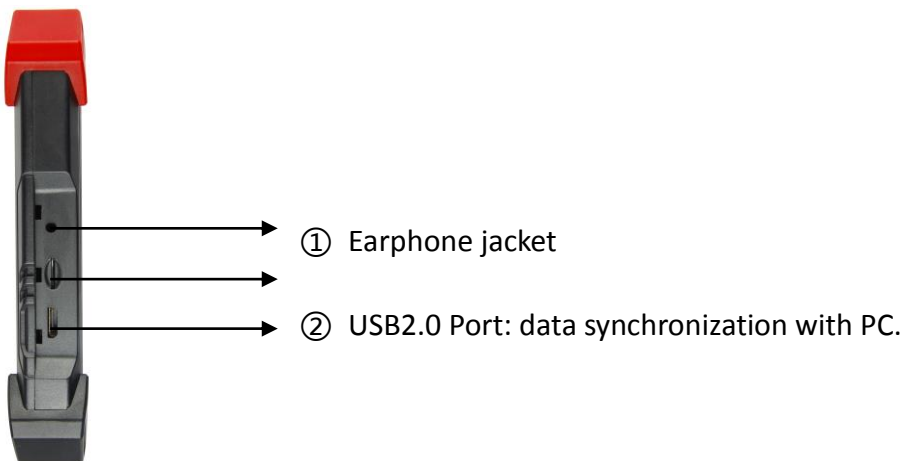

3. PS80 Technical Parameters

Operating System:	Android
Processor:	Quad-core 1.6GHz Processor
Memory:	2G RAM,32G FLASH
Display:	8.0 inch capacitive touch screen with 1024x600p resolution

Camera:	Rear camera, 5.0 Megapixel, AF with Flashlight
Sensors:	Gravity Sensor, Ambient Light Sensor
Auto Input/Output:	Microphone, Dual Speakers, 4-Band 3.5 mm stereo/standard headset jack
Auto Input/Output:	4000mAh, 7.4V lithium-polymer battery
Power and Battery:	12V
Power Consumption:	29.6W
Operating Temperature:	-20 to 50°C(-4 to 126°F)
Humidity:	<90%
Dimension (L×W×H):	240×177×30mm

CHAPTER II How to Use the PS80

1. PS80 Activation

1.1. Please activate PS80 before you use it to test vehicles. And please connect WiFi first.

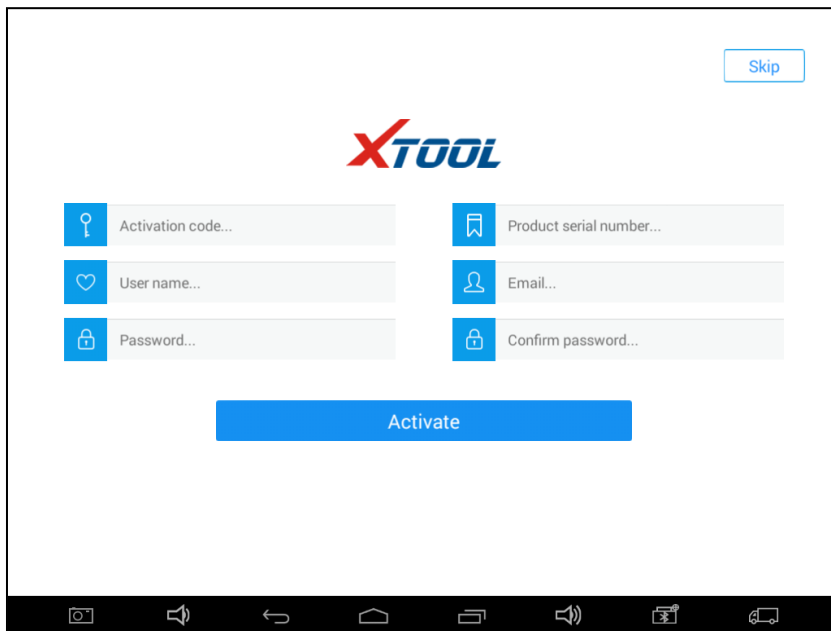

1.2. Input activation code (on the Quality Certificate cover), product serial number (each device will have a serial number and activation code), nickname (workshop's name or user's nickname), login account (can be your email address or cell phone number) and password, the system will then save it. Activation is a one time process. The diagnostic application will start after activation.





2. PS80 Main Interface and Functional Buttons Descriptions

2.1. Main Interface





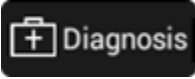
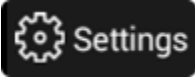
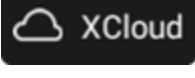
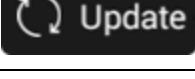
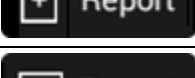



Tap on PS80 application icon, the main interface and sub-menus will be shown as below. ▼



2.2. Sub-menus and Function Buttons

Function Buttons	Descriptions
	Opens the PS80 diagnostic application. It can read diagnostic information, view live data, perform actuation tests and special functions etc.
	By selecting “Setting”, users can access the language setting and other system related settings.
	Online Communication Platform for PS80 users. (English version is coming soon)
	Click UPDATE after PS80 is connected to internet, then you can download the latest diagnostic software directly to PS80.
	Users can view all the diagnostic reports and diagnostic data generated in the diagnosis process.
	Users can get remote help and support when needed.

2.3. Toolbar Function Buttons

Function Buttons	Descriptions
	For screen captures or for turning on the camera
	Turn down the volume
	Returns to previous interface
	Returns to the main interface of Android System
	Shows (recently used) applications
	Turn up the volume
	Click here to return to the diagnostic interface
	Click here to return to diagnostic vehicle models interface

3. Vehicle Connection Diagnosis

3.1. Vehicle Connection Test

a. Turn on PS80 tablet

b. Connect cables and PS80 in following order: ①→②→③→④

c. Switch on the ignition and tap on PS80 application to test vehicles. (Shown as follows)

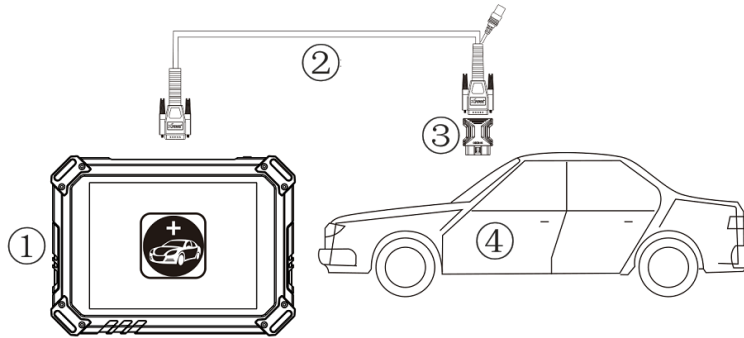

① PS80 Mainframe

② Main Test Cable

③ OBDII Connector

④ Vehicle

3.2. Precautions before Use

3.2.1. The vehicle power supply has to meet the normal voltage limits DC 9-12V.

3.2.2. Users should check the position of the DLC port and ensure the OBDII 16pin connector and the DLC port are correctly aligned before attempting to connect.

3.2.3. When taking some special functions tests, users are required to operate the device according to operating instructions. For vehicle, it has to strictly meet the requirements, for example, the conditions that some vehicle models need to be

reached are as follows: engine temperature 80°C/105°C, turn off the loads (such as headlights, air-conditioner, etc.), put accelerator pedal in released position, etc.

3.2.4. If users can not find the tested vehicle model or electronic control system in the PS80 test menu, they may need to update the software or consult Xtool technical service department.

3.2.5. Please ensure that only official XTOOL cables and connectors are used to prevent damage to the unit.

3.2.6. Before powering off the unit, please ensure that you cancel or complete the

current task or function and return to the main interface, then power off.

3.2.7. Do not use excessive force to operate the touch screen.

3.2.8. During long period of non-use, please disconnect the power and turn off the PS80 unit.

4. Diagnosis

4.1. Menu Options

4.1.1. After the scanner is connected to the vehicle and paired with PS80 mainframe via wired or wireless connection, diagnosis can be performed. The diagnostic interface is as shown below:



4.1.2. Users can choose the relevant menu for the vehicle being tested: selection for **Europe** will enter the European cars menu, selection for **Asia** will enter the Asian cars menu, selection for **America** will enter the American cars menu. Users also can input the vehicle model to search.

4.1.3. Besides the usual system diagnostic functions, XTOOL have also developed a series of special diagnostic functions for certain vehicles as follows:

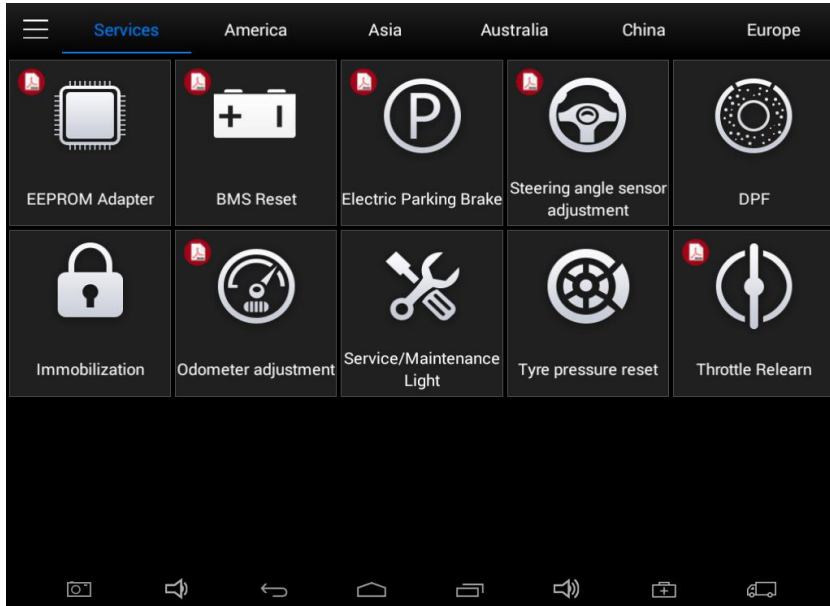

4.2. Test Functions

4.2.1. Using **VW** as an example, select **Diagnosis**, then select **EUROPE**. Choose the **VW** word. If the word is not showing on the screen, please swipe up or down to display it.

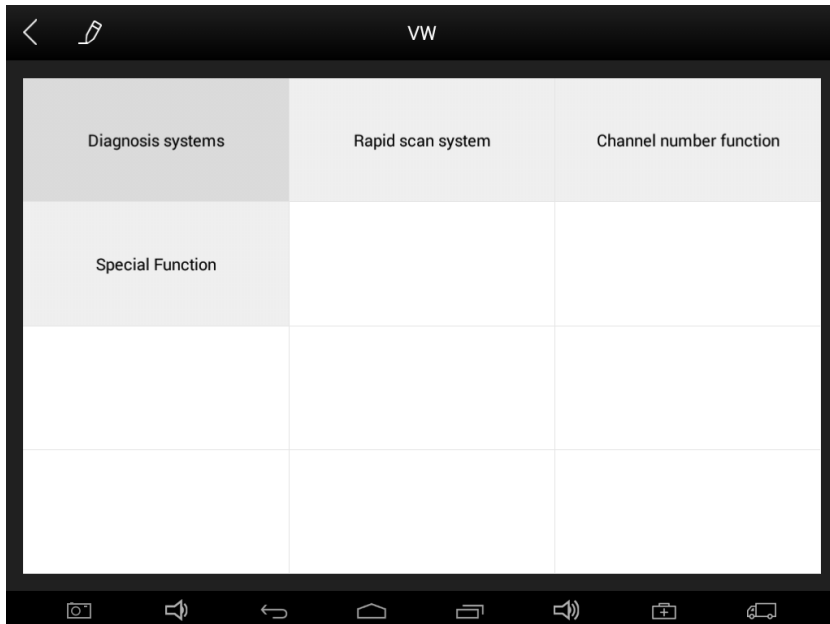

PLEASE NOTE: Different vehicles have different menus and systems.

Common main function menu includes the following options:

Read ECU: This function is to read the ECU version information, which is the equivalent of “System Identification” or “System Information” in some electronic control systems.

This will allow you to read ECU related software and hardware versions, models and production date of diesel engine, part number, etc.

Read DTCs: read the trouble codes that are stored in the ECU.

Clear DTCs: clear current and historical trouble codes memory in ECU. The trouble codes can not be erased without eliminating the fault that the code relates to. TIP: Save or print the currently stored fault codes before clearing them to provide help in the case of an intermittent fault.



Read Live Data: This will allow you to read the parameters of the system being interrogated, such as oil pressure, temperature, engine speed, fuel oil temperature, coolant temperature, intake air temperature, etc.

Special Functions: Typically these will include Injector programming, DPF Regeneration/reset, component learning etc.

Actuation/Activate Components Test: Activations allow you to operate supported components for troubleshooting purposes. Components range from instrument cluster indicators, to the engine injection valves, to the boot lid latch.

Activations are also used to test components for function and to check systems for correct operating ranges.

4.2.2. Toolbar function buttons descriptions

Function Buttons	Descriptions
	Returns to previous interface
	Print test data
	Click to record the data, click again to send your feedback to XTOOL service center

After clicking the data record button the second time the data feedback page will appear as shown below, showing diagnostic software version, vehicle being tested, and the steps performed in the diagnostic process. Users can then enter the nature of the problem and any other relevant information and send the form to the Xtool engineering department.

Cancel
FEEDBACKS
Send

SUBJECT: 2015/05/28 07:18:56

PROBLEM:

VEHICLE INFORMATION

GM -> after 2010 -> (D)2013 ->
 Passenger Car -> Chevrolet -> F ->
 Powertrain -> [J] 6.2L V8 [L99] ->
 Automatic Transmission -> Engine
 Control Module -> Diagnostic Trouble
 Codes [DTC]

SOFTWARE INFORMATION

EN_PS_GM_V7.01

USER INFO

CONTACT:

TEL:

EMAIL:

ATTACHMENT

0.16 K

4.3. Read ECU

This function is used to read ECU version information, which is the equivalent of “System Identification” or “System Information” in some electronic control systems. This will allow you to read ECU related software and hardware versions, models and production date of diesel engine, part number, etc. shown below:

01 - Engine

01-Control Unit Info

VIN:	WVGA597P5DD038038
VW/Audi part number:	7P0907401G
System description:	3.0TDI EDC17
Hardware version:	H41
Software version:	0002
FAZIT identification:	BPG-81018.04.1313080026

OK

4.4. Read DTCs

Select **Read Fault Codes** to read the trouble codes stored in the ECU. The screen will show the trouble codes and their definition, shown below:

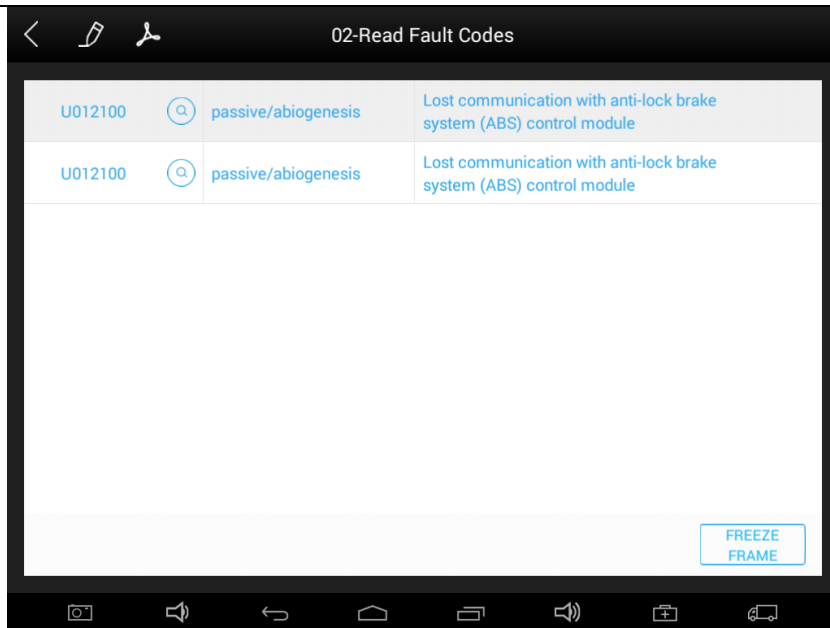

Tip: In the process of diagnosis, if the device shows “System is OK” or “No Trouble Code”, it indicates that the ECU has not detected a fault in any of the circuits that it monitors. If there is a fault which is not being recorded it may be that the fault is with a part of the system not under the control of ECU, such as a mechanical system fault. It is also possible that the signal of a system sensor may be incorrect but still within the ECUs stored limits, this can be verified in Live Data.

4.5. Clear DTCs

4.5.1. Return to the previous step, select **Clear Fault Codes** to clear the current and historical trouble codes memory in ECU. Performing this function will clear all the current and historical trouble codes. Please ensure that the trouble codes have been recorded before clearing, shown below:

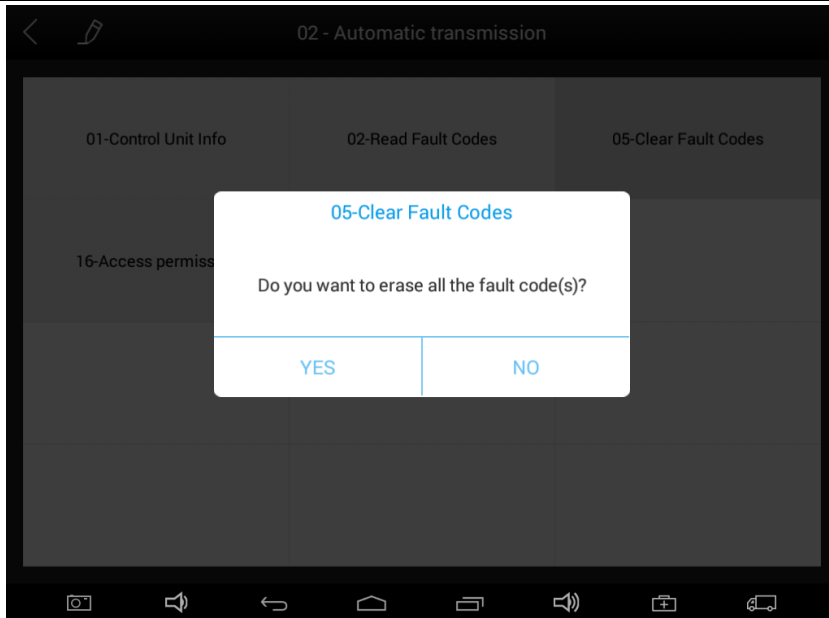

4.5.2. Click **YES** to confirm the operation, if the communication is normal, it will show **“Trouble Codes Successfully Cleared”** or **“Trouble Codes Cleared”**. Generally, users will need to re-read trouble codes after clearing them to confirm that the trouble codes have been cleared.

4.6. Read Live Data

System control units or ECUs send out operating parameters and working status of various components in the form of an Electronic Signal, here Electronic Signal refers to Live Data. Common Engine Live Data includes Engine Speed, Throttle Position Sensor Voltage, Oxygen Sensor Voltage, Coolant Temperature, Spark Advance Angle, Idle Speed Switch State, Intake Air Temperature, Intake Pressure, etc.

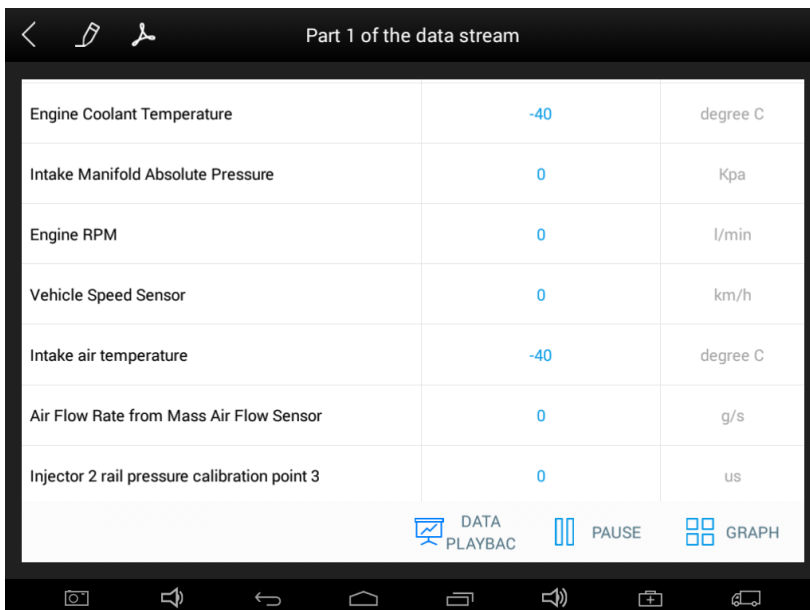

Tip: Live Data is important function that can be used to help technicians further diagnose a problem. This function requires technicians to be familiar with sensor data of each system, control signals and control modes. Tip: Save known good live data readings for comparison.

(The following are some test conditions and typical values of common live data)

Test Items	Unit	Normal Data	Test Conditions & Typical Values
1.Engine Speed	rpm	0-6000	Engine warmed-up: 750-850rpm
2.Engine Coolant Temperature	°C	-40-150	Engine warmed-up: 85-95°C
3.Throttle Percentage		0-100	Throttle closed: 0%, Throttle wide-open: > 85
4.Injecting Pulse Width	ms	0-15	Engine warmed-up: 3.5-4.5ms
5.Intake Air Temperature	°C	-40-150	Show value a little higher than ambient temperature
6.Battery Voltage	v	0-15	Idle speed: 11-13.5V
7.Injection closed-loop correction		0-1.99	
8.Load	ms	0-15	Dependent on throttle position etc
9. Angle of Ignition Advance	°C	0-50	Engine warmed-up: 5-15 °C variations
10.Air Intake	kg/h	0-255	Engine not started: 0
11.Intake Pressure	hpa	0-1013	Engine not started: 1013hpa
12. Idle-speed Adjustment Status		0-255	
13.Oxygen Sensor	mv	0-1000	Engine warmed-up: 50-960mv variations

Display Modes

There are three modes with which to view Live Data, users can choose the optimum mode according to their own needs and different parameter types.

Digital Mode: Displays parameters in numerical form.

Dashboard Mode: Displays parameters in the form of simulated instrument graphics.

Graph Mode: Displays parameters in graph form.

Part 1 of the data stream

Engine Coolant Temperature	-40	degree C
Intake Manifold Absolute Pressure	0	Kpa
Engine RPM	0	l/min
Vehicle Speed Sensor	0	km/h
Intake air temperature	-40	degree C
Air Flow Rate from Mass Air Flow Sensor	0	g/s
Injector 2 rail pressure calibration point 3	0	us

DATA PLAYBACK PAUSE GRAPH

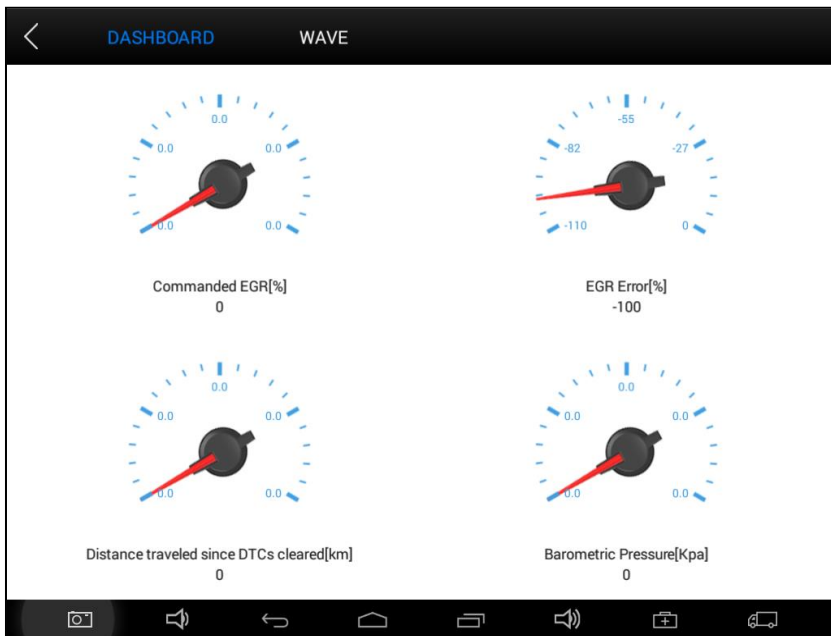

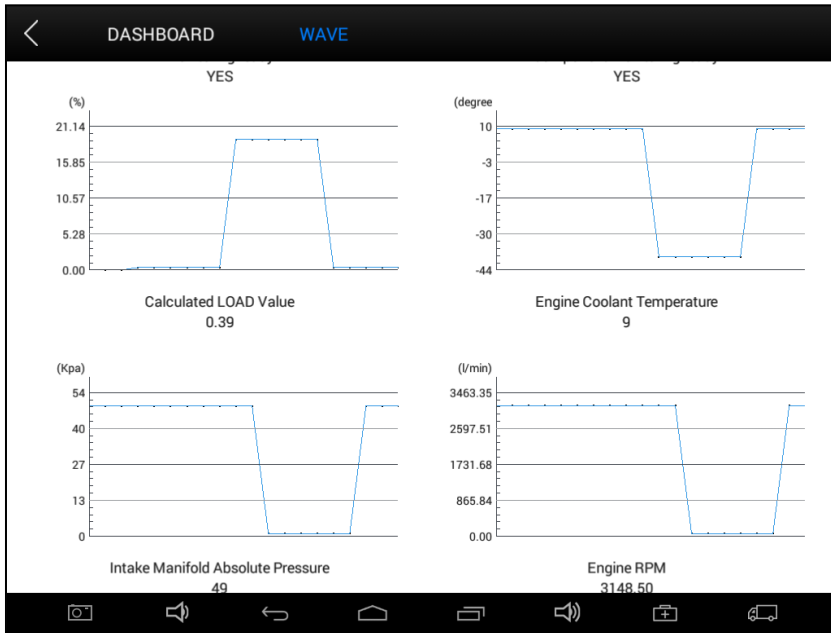

4.7. Special Functions

Different vehicle makes and models will have different special functions.



4.8. Actuation/Active Components Test

Test Conditions: Ignition on engine off.

If the engine is started or an engine rotation speed signal is received, component actuation will be interrupted.

In the process of actuating components, a single component will always be in the trigger status until the next component is activated.

Actuating components can be checked by hearing or touching.

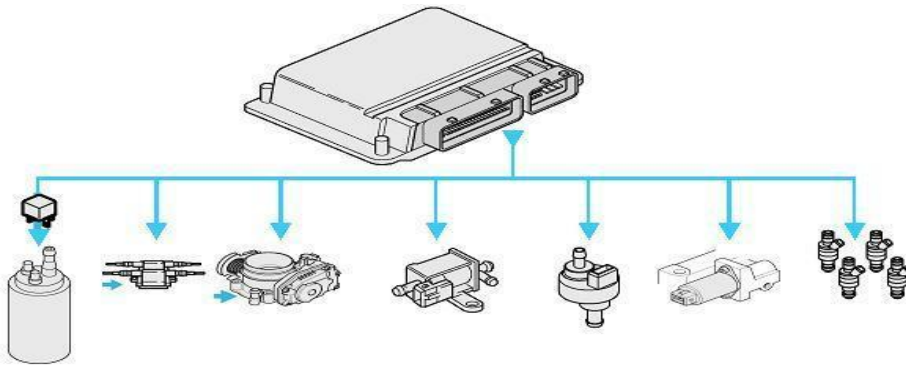

4.8.1. Return to **Dynamic Diagnostic Data**, enter **Test Actuator** and it will show the menu of the components that are available to actuate, shown below:

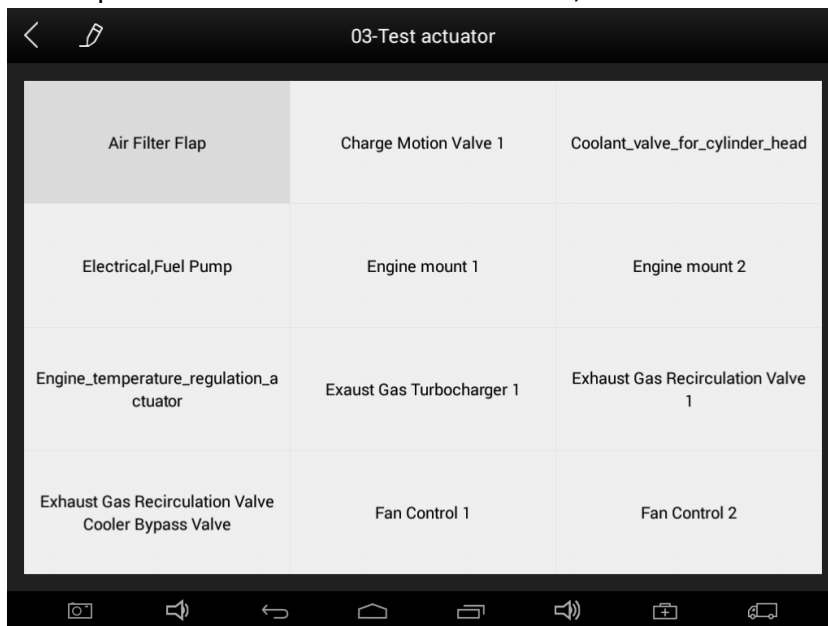

Tip: Actuating Components Test performs function tests for system components. When performing this function, the diagnostic tool will simulate the ECU signal to enable the user to judge whether the actuating components or circuits are working correctly.

5. Settings

By selecting **Settings** users can set the language, unit and other system related options:

Languages: select the language. Please tick the required option from the multi-language options on the right.

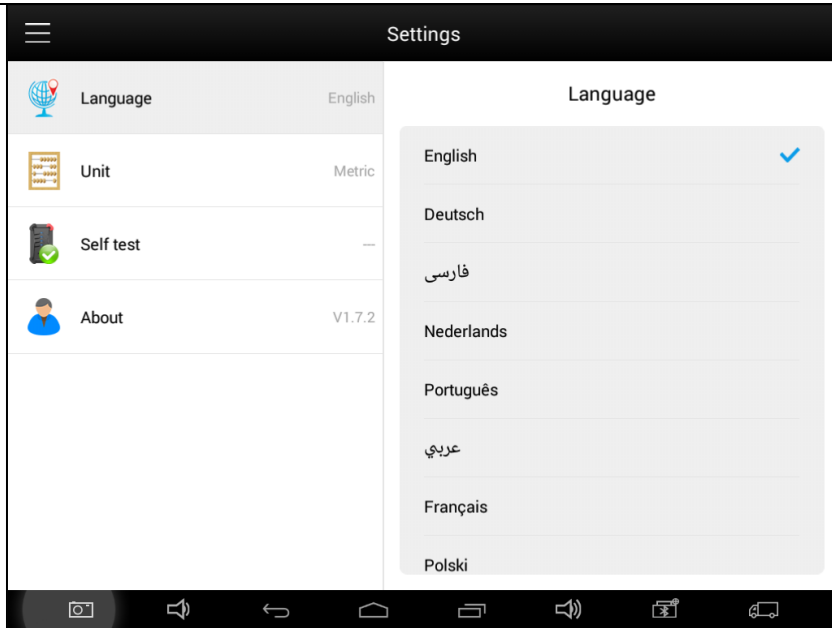

Units: Select unit of measurement. Users can select Metric or British Unit.

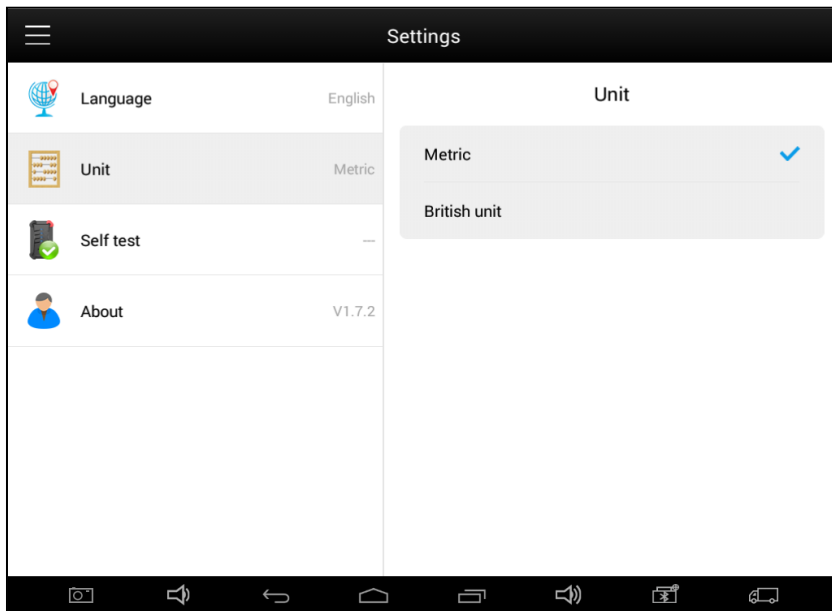

6. XCloud (English version is coming soon)

All the auto maintenance technicians who use our products can not only look up the maintenance information that we put on our cloud service platform conveniently, and combine the diagnosis result to query, and communicate with other Xtool users in our forum, but can also access various online databases of maintenance and diagnostic skills and vehicle maintenance plans.

7. Update

PS80 updates directly via the Internet using WiFi or wired connection. To access the update application open the PS80 application and click UPDATE , shown below:

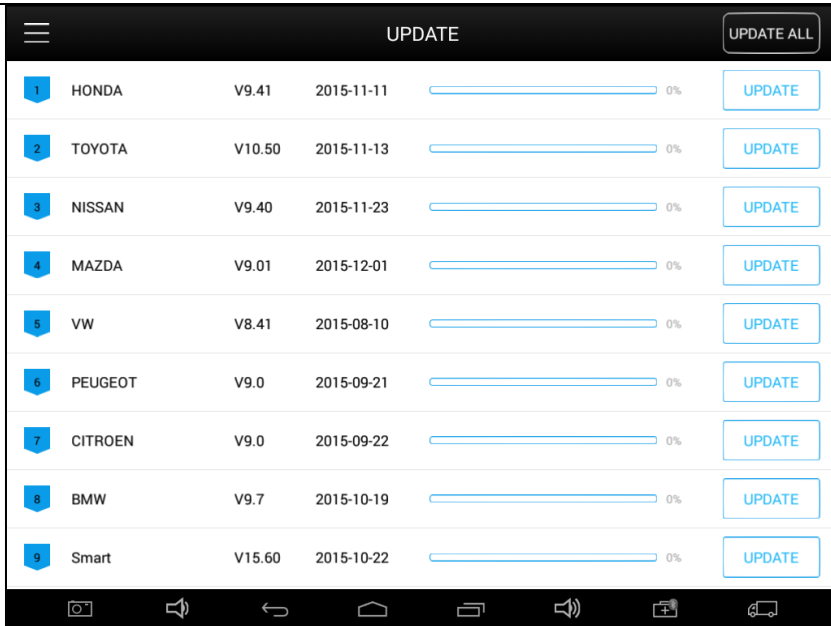

8. Report

Report is used for viewing and printing the saved files, such as Live Data, Trouble Codes or pictures generated in the process of diagnosis, users also can view a record of which cars have been previously tested. It includes three parts: PDF Files, Pictures and Data Playback.

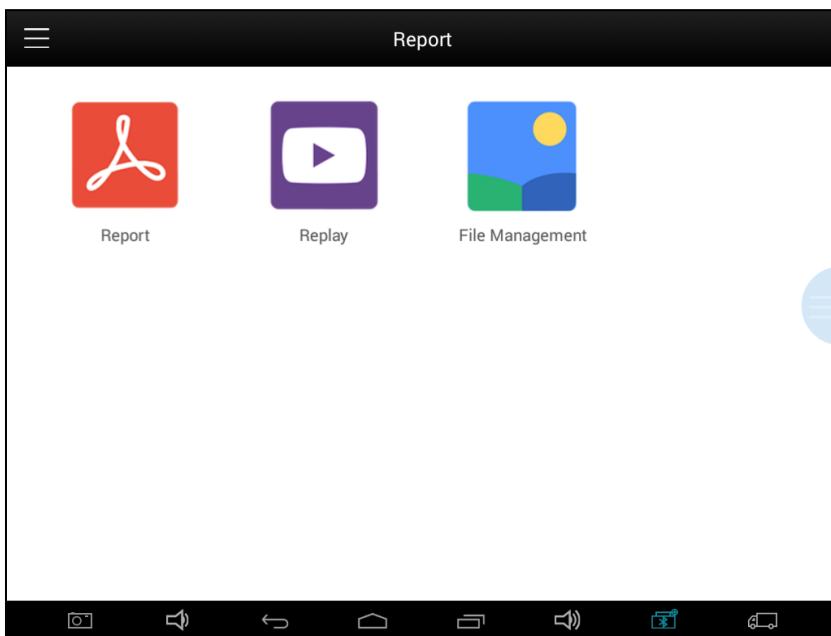

8.1. PDF Files:

8.1.1. PDF files are the diagnostic reports of Live Data or Trouble Codes that have been saved during diagnosis. Entering **PDF** will allow you to view and print these reports.



8.1.2 Click PDF icon to generate PDF when you want to save the trouble code report

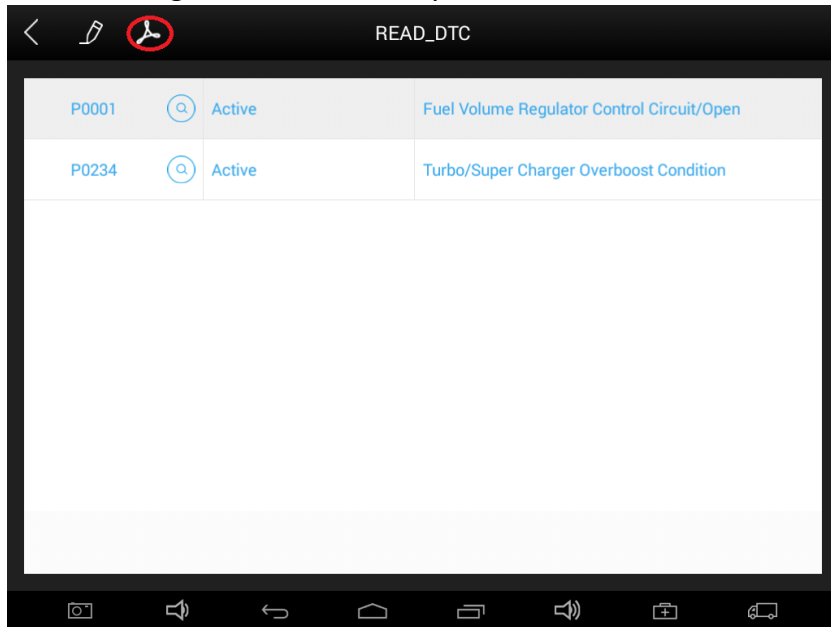

8.2. Data Replay:

With Data Playback you can play back recorded Live Data & freeze frame data.

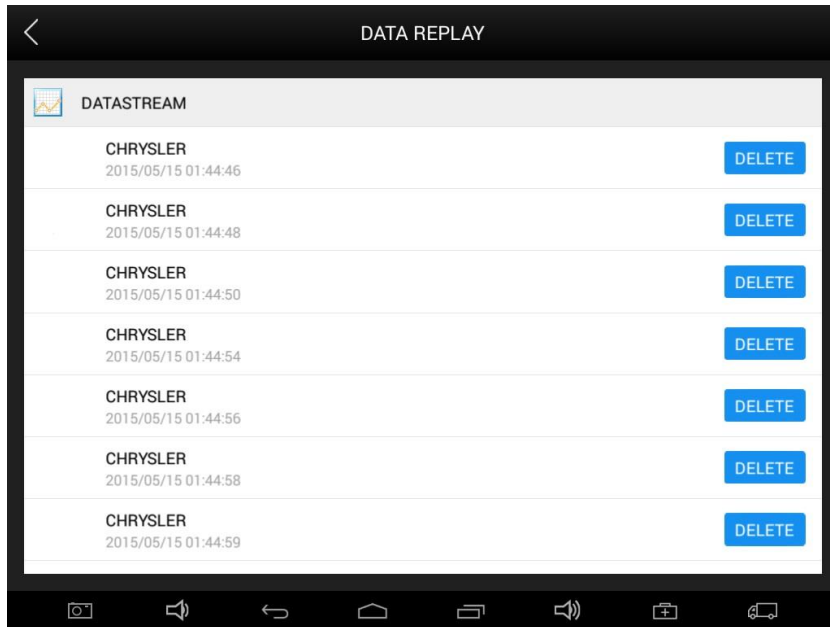

8.3. File Management:

Pictures are all the screen capture files saved in the diagnosis process.

9. Remote

If users encounter problems and are not able to solve them, they can open this application and ask for remote assistance.

How to get remote assistance from Xtool Technical Assistance Center:

- a. Open PS80
- b. Click **Remote** and open the **TeamViewer** interface. Generate and display device ID.
- c. Your partner will also need to download and install **TeamViewer**.
- d. Inform your partner of your **TeamViewer** ID and password to enable them to begin remote access of the PS80.

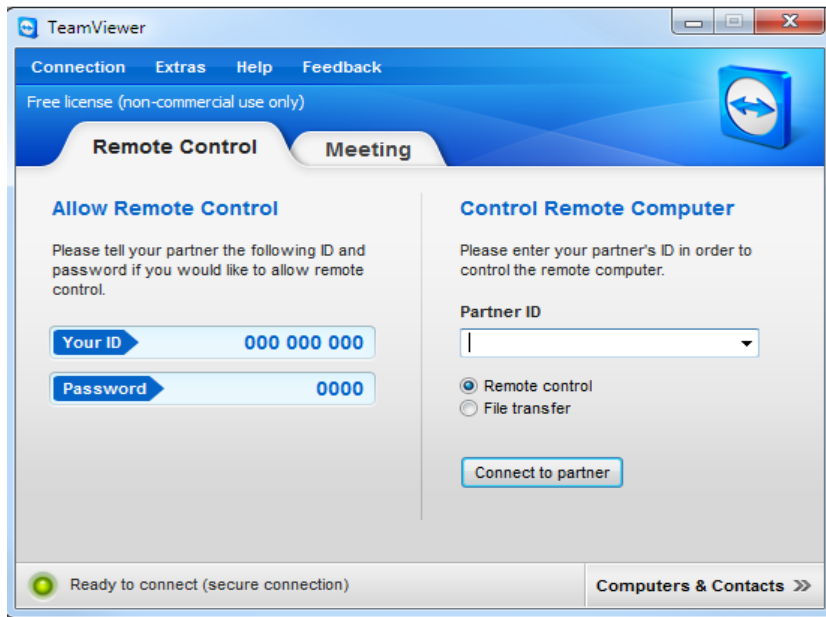

CHAPTER III Examples of Diagnostic Link Connector Locations.

1. Diagnostic Link Connectors Locations of Various Vehicle Models



*AUDI A6: the OBD plug is on the lower left side of the dashboard, use SMART OBDII-16 connector.



*VW Bollywood 1.8: the OBD plug is below the console, use SMART OBDII-16 connector.



*Benz S320,220 Chassis: the OBD plug is below the dashboard, use SMART OBDII-16 connector.

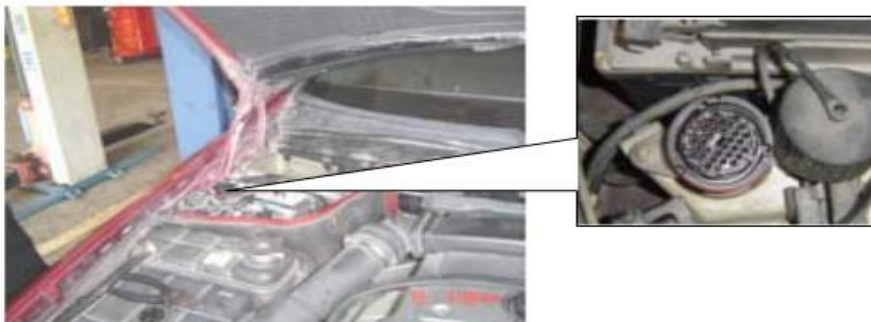

*Benz C180: the OBD plug is on the left hand side of the engine bay, use Benz-38 connector.



*Benz 300SEL 140 chassis: the OBD plug is on the left hand side of the engine bay, use Benz-38 connector.



*GM Buick: the OBD plug is below the dashboard, use SMART OBDII-16 connector.



*GM Buick GL8 : the OBD plug is below the dashboard, use SMART OBDII-16 connector.

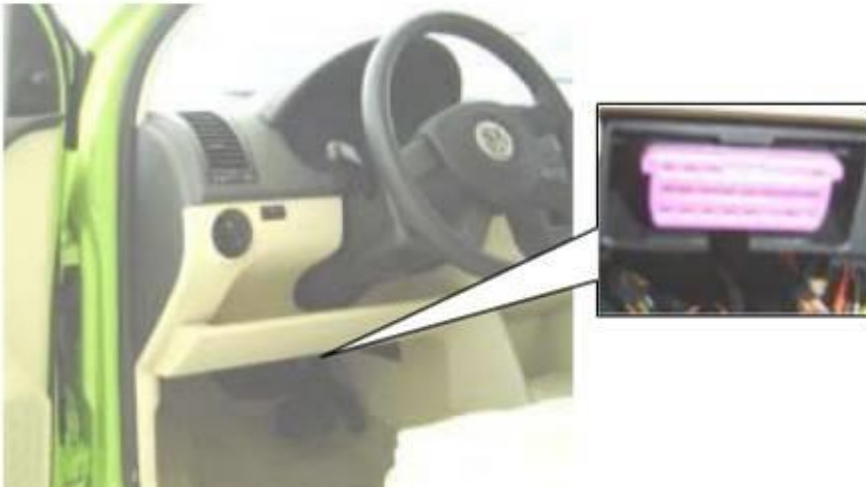

*VW POLO: the OBD plug is below the dashboard, use SMART OBDII-16 connector.



*BMW 735I: the OBD plug is in the right hands side of the engine bay, use BMW-20 connector.

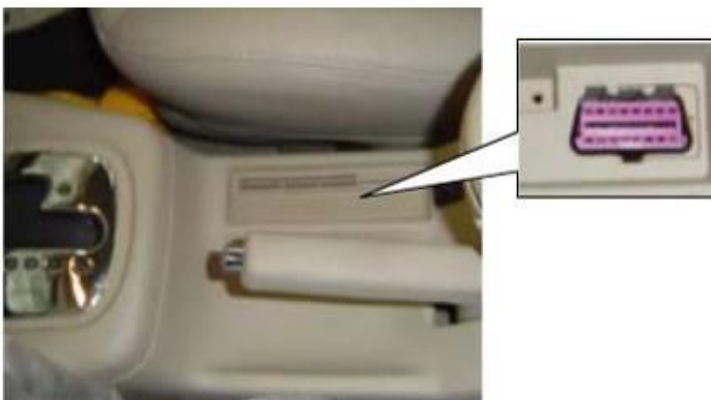

*VW Passat B5: the OBD plug is behind the gearlever and beside the parking brake lever. Lift the cover to access it. Use SMART OBDII-16 connector.

2. Location Diagram of Vehicle Diagnostic Link Connectors

Location diagram of pick-up truck diagnostic link connectors:

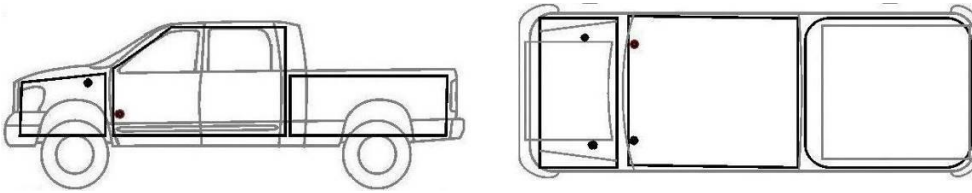

Location diagram of utility vehicles diagnostic link connectors:

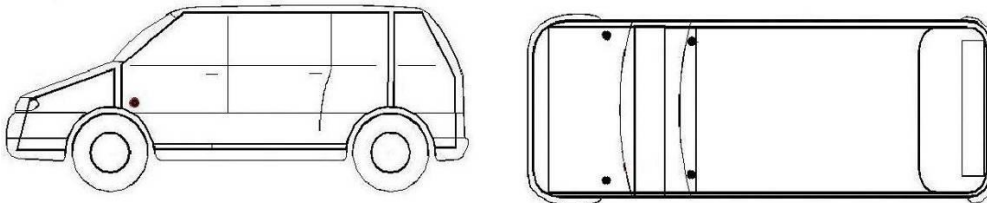

Link diagram of small car diagnostic link connectors:

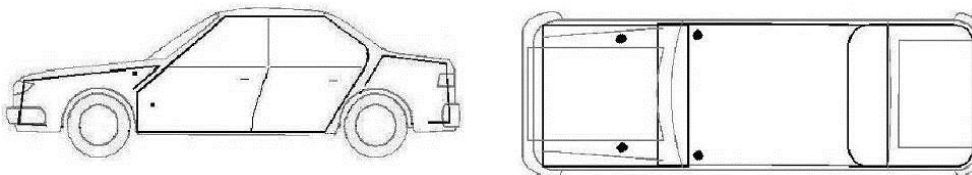

NOTE: Each vehicle manufacturer may use additional pins to diagnose a variety of systems. Not every manufacturer uses the same standard. The function on a certain pin will vary from manufacturer to manufacturer. Verify with the manufacturer.

3. Diagnostic Link Connectors Terminal Definition and Communication Protocols

3.1. Standard OBDII Diagnostic Link Connector:

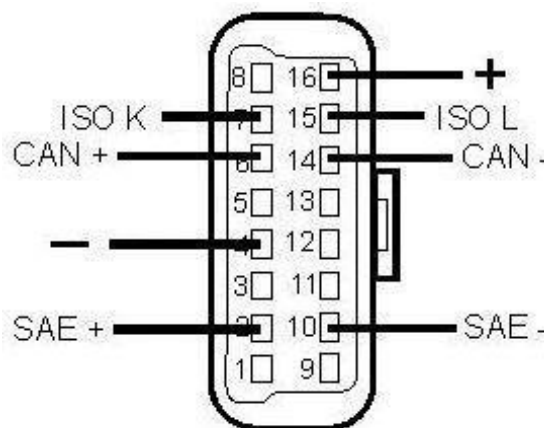

Pin Definition (Reference material)

Various pin definitions as follows:

1. Manufacturer definition
2. SAE J1850 bus positive
3. Manufacturer definition
4. Bodywork site
5. Signal site
6. ISO 15765-4 defined CAN high
7. ISO9141 and ISO14230 defined K line
8. Manufacturer definition
9. Manufacturer definition
10. SAE J1850 bus negative
11. Manufacturer definition
12. Manufacturer definition
13. ISO 15765-4 defined CAN low
14. ISO9141 and ISO14230 defined L line
15. Permanent positive voltage

[1] 1, 3, 8, 9, 11, 12 and 13 are defined by manufacturer.

[2] 2, 6, 7, 10, 14 and 15 are used for diagnostic communication. Unused definitions can be defined by manufacturers.

Shenzhen Xtooltech Co., Ltd

Company address: 2nd Floor, Building No.2, Block 1, Excellence City, No.128,
Zhongkang Road, Shangmeilin, Futian District, Shenzhen, China

Factory address: 2/F, Building 12, Tangtou Third Industrial Zone, Shiyan Street,
Baoan District, Shenzhen, China

Service Hotline: 400-880-3086/ 0755-21670995

Email: marketing@xtooltech.com

Fax: 0755-83461644

Website: www.xtooltech.com