

FORD, LINCOLN, MUSTANG ALL KEYS LOST

PROGRAMMING CONNECTING METHODS

①Development Background

In all keys lost, almost proximity keys of FORD 2016- car models will fail to read IMMO data by regular communication ways, as its IMMO alarm is active. So FORD all keys lost cables are developed to read data and achieve adding keys, all keys lost.

Remarks: no need to repeatedly disconnect/connect battery cables.

②Equipment Overview

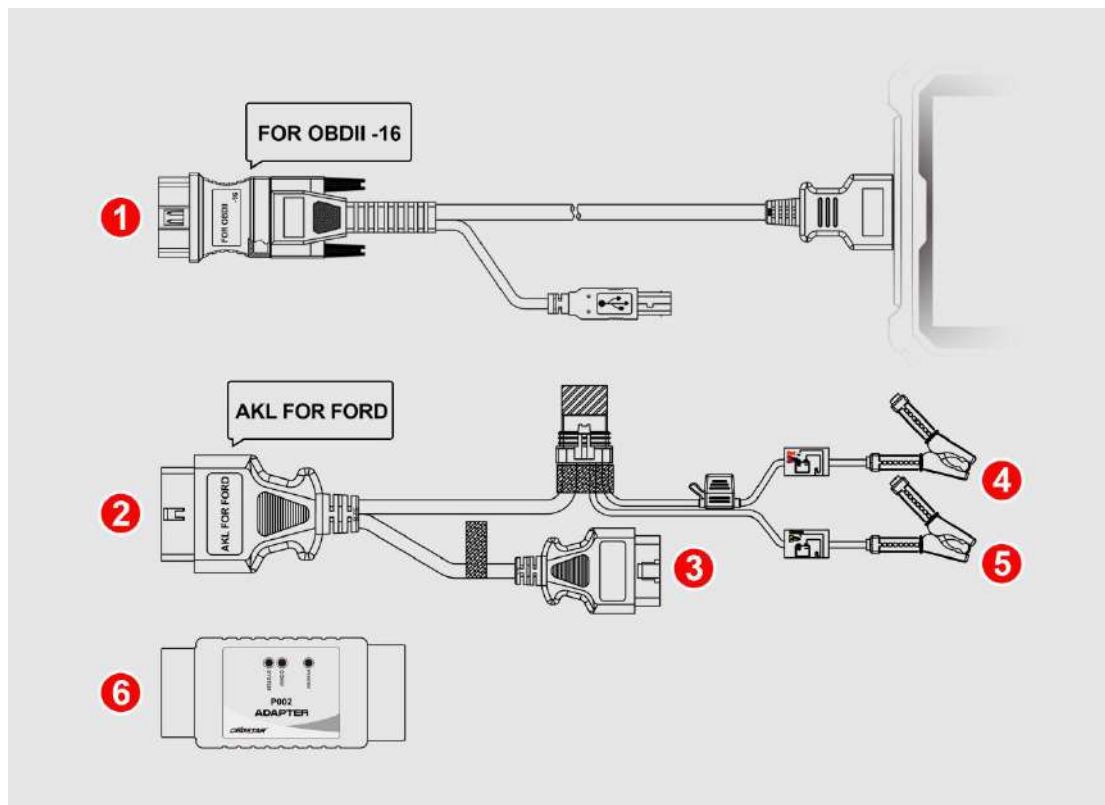

1. Diag cable OBD connector(male)
2. Connect P002 connector(female)
3. Connect vehicle OBD diag connector(male)
4. Red clip(battery terminal)
5. Orange clip(positive cable)

6. P002 adapter

③Support Car Models

ECOSPORT 2018-
EDGE 2017-
ESCAPE 2020
ESCORT 2018-
EXPEDITION 2020
EVEREST 2017-
EXPLORER 2017-
F-150 2017-
F-250 2017-
FOCUS 2018-
MUSTANG 2017-
TAURUS 2017-
MONDEO 2017-
FUSION 2017-
RANGER 2017-
AVIATOR 2020
CONTINENTAI 2016-
CORSAIR 2020
MKC2015-
MKT 2020
MKX2015-
MKZ2015-
NAUTILUS 2018-
NAVIGATOR 2018-

④All Keys Lost Programming

Operation steps

IMMO⇒Americas⇒FORD LINCOLN MERCURY⇒V34.45⇒FORD⇒EUROPE⇒EDGE⇒PROXIMITY⇒2016.4-



IMMO	FORD/LINCOLN/MERCURY	SN:951499990029	
FORD/LINCOLN/MERCURY V34.45 ✓			
FORD/LINCOLN/MERCURY V34.43			
 FORD/LINCOLN/MERCURY			
		Esc	Enter
FORD/LINCOLN/MERCURY	FORD/LINCOLN/MERCURY V34.45		
FORD ✓			
LINCOLN			
MERCURY			
		Esc	Enter

FORD/LINCOLN/MERCURY		FORD
AFRICA		
ASIA		
AUSTRALIA		
BRAZIL		
EUROPE ✓		
INDIA		
		Esc
		Enter

FORD/LINCOLN/MERCURY		EUROPE
B-MAX		
C-MAX/C-MAX FL		
COUGAR		
ECOSPORT		
EDGE ✓		
ESCAPE		
		Esc
		Enter

FORD/LINCOLN/MERCURY		EDGE
BLADE		
PROXIMITY		✓
REMOTE		
		Esc Enter

FORD/LINCOLN/MERCURY		PROXIMITY
2021		
2016.4-		✓
2014-2016.3		
-2013		
		Esc Enter

Functions menu

FORD/LINCOLN/MERCURY 2016.04-

Key Count ✓

Add a Key

Erase Keys

All Keys Lost

Info Pictures Tips Remote Esc Enter

Button—Tips

Help Data

DOC10.02

Notice

I.ALK function equipment list

Info Pictures **Tips** Remote Esc

Help Data

DOC10.02

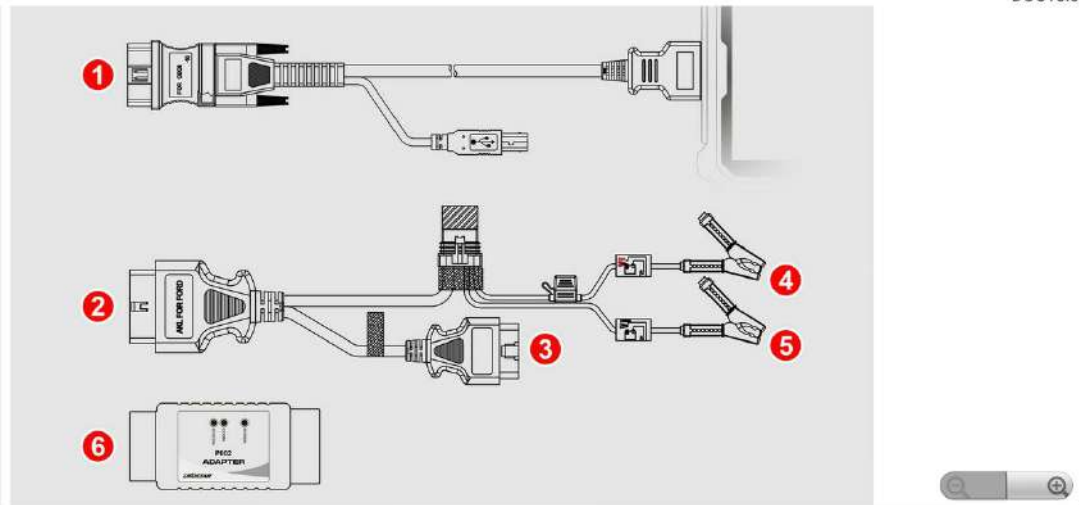

Info

Pictures

Tips

Remote

Esc

Help Data

DOC10.02

- 1: Diag cable OBD connector(male)
- 2: Connect P002 connector(female)
- 3: Connect vehicle OBD Diag connector(male)
- 4: Red clip(Battery terminal)
- 5: Orange clip(Positive cable)
- 6: P002 adapter

II. ALK operation steps

Step 1: Connect 1, 6, and 2 together;



Info

Pictures

Tips

Remote

Esc

II. ALK operation steps

Step 1: Connect 1, 6, and 2 together;

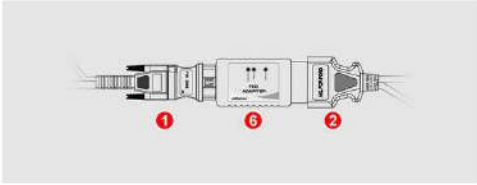

Step 2: Plug 3 into vehicle's OBDII diag connector;



Info

Pictures

Tips

Remote

Esc

Step 2: Plug 3 into vehicle's OBDII diag connector;



Step 3: Remove the positive cable of the vehicle from the positive terminal of the battery (**note: Don't short-circuit the positive cable with the vehicle body!!!**), clamp the positive terminal with NO.4, clamp the positive ca

Info

Pictures

Tips

Remote

Esc

Help Data

DOC10.02

Step 3: Remove the positive cable of the vehicle from the positive terminal of the battery (**note: Don't short-circuit the positive cable with the vehicle body!!!**), clamp the positive terminal with NO.4, clamp the positive cable with NO.5;



Info

Pictures

Tips

Remote

Esc

Help Data

DOC10.02

Step 4: Follow the device prompts to ALK;

1. Select All Keys Lost menu;



Info

Pictures

Tips

Remote

Esc

Help Data

DOC10.02



1. In the following steps, the device will automatically try to disconnect and connect the vehicle battery, please do not perform other operations;
2. When the battery is reconnected, the device will try to silence the vehicle alarm, if the operation is not successful, The device will automatically try multiple times;
3. In the following operation, you will be able to choose whether to clear the original car key.



Info	Pictures	Tips	Remote	Esc
------	----------	-------------	--------	-----

Help Data

DOC10.02

The device is trying to disconnect the vehicle battery, please be patient...

The device is trying to connect the vehicle battery, please be patient...



Info	Pictures	Tips	Remote	Esc
------	----------	-------------	--------	-----

Help Data

DOC10.02

2. Read DFlash;



3. Reading data is complete, Anti-theft alarm reactivated, Please be patient and wait for the anti-theft alarm to be automatically lifted;



Help Data

DOC10.02

3. Reading data is complete, Anti-theft alarm reactivated, Please be patient and wait for the anti-theft alarm to be automatically lifted;

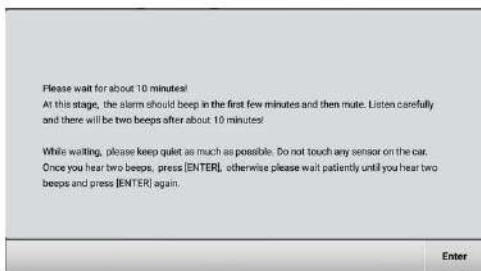

4. Do you want to erase all keys of the current vehicle?(if you want to erase all keys, it needs at least 2 keys to complete key programming)

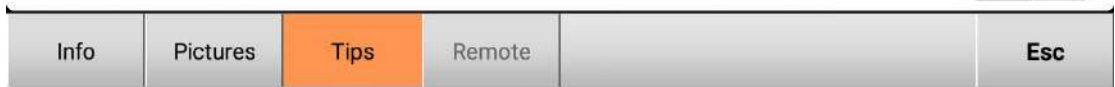

Help Data

DOC10.02

4. Do you want to erase all keys of the current vehicle?(if you want to erase all keys, it needs at least 2 keys to complete key programming)

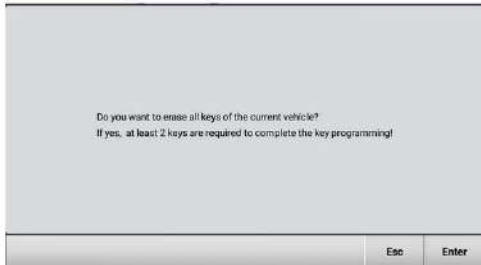

5. Follow the device prompts to complete key programming;



Help Data

DOC10.02

5. Follow the device prompts to complete key programming;

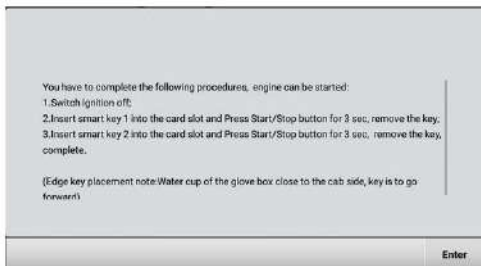

Step 5: Remove all the connections between the ALK FOR FORD cable and the vehicle, connect the positive cable of the vehicle to the positive terminal of the battery, then start the vehicle, and verify that all functions of the key are normal;

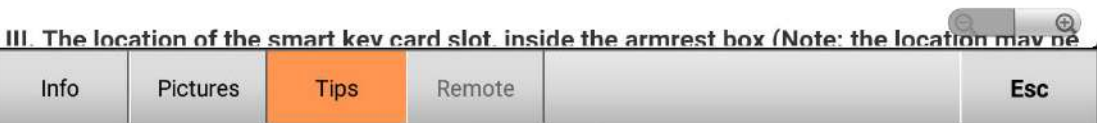

Help Data

DOC10.02

III. The location of the smart key card slot, inside the armrest box (Note: the location may be different for different models)



Execute the function—All Keys Lost

FORD/LINCOLN/MERCURY 2016.04-

Key Count

Add a Key

Erase Keys

All Keys Lost ✓

Info

Pictures

Tips

Remote

Esc

Enter

FORD/LINCOLN/MERCURY Information

This function is available by connecting the server, please ensure the Internet connection is normal.

Esc

Enter

FORD/LINCOLN/MERCURY Information

1. This function requires the use of P002 adapter and ALK FOR FORD cable. For the usage method, please refer to the operating instructions on this interface;
2. Have the P002 adapter and ALK FOR FORD cable been correctly connected to the vehicle?

Instructions

Esc

Enter

Button—Instructions

FORD/LINCOLN/MERCURY Instructions

Instructions

I.ALK function equipment list

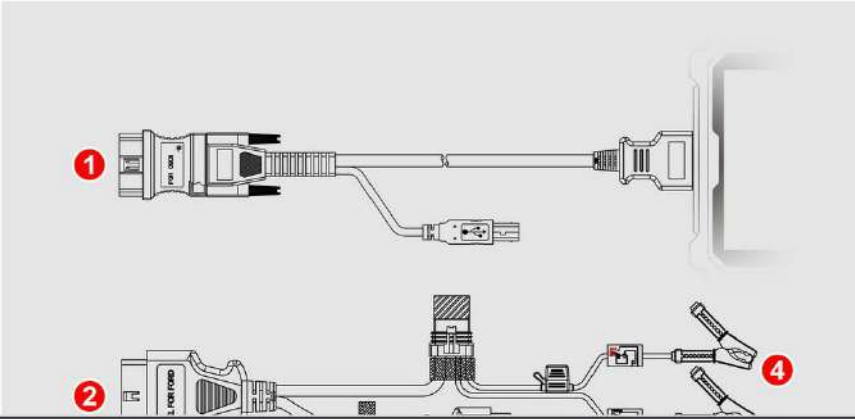

Esc

FORD/LINCOLN/MERCURY Instructions

Instructions

I.ALK function equipment list

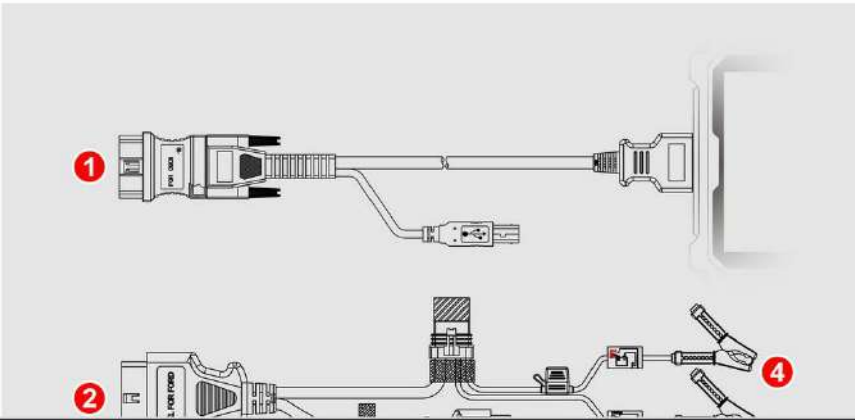

Esc

FORD/LINCOLN/MERCURY Instructions

- 1: Diag cable OBD connector(male)
- 2: Connect P002 connector(female)
- 3: Connect vehicle OBD Diag connector(male)
- 4: Red clip(Battery terminal)
- 5: Orange clip(Positive cable)
- 6: P002 adapter

II. ALK operation steps

Step 1: Connect 1, 6, and 2 together;

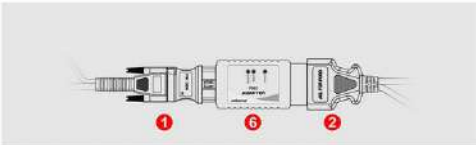

Esc

FORD/LINCOLN/MERCURY Instructions**II. ALK operation steps**

Step 1: Connect 1, 6, and 2 together;

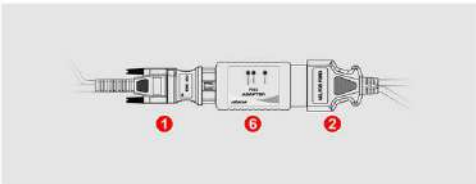

Step 2: Plug 3 into vehicle's OBDII diag connector;



Esc

FORD/LINCOLN/MERCURY Instructions

Step 2: Plug 3 into vehicle's OBDII diag connector;



Step 3: Remove the positive cable of the vehicle from the positive terminal of the battery (**note: Don't short-circuit the positive cable with the vehicle body!!!**), clamp the positive terminal with NO.4, clamp the positive cable with NO.5;

Esc

FORD/LINCOLN/MERCURY Instructions

Step 3: Remove the positive cable of the vehicle from the positive terminal of the battery (**note: Don't short-circuit the positive cable with the vehicle body!!!**), clamp the positive terminal with NO.4, clamp the positive cable with NO.5;



Esc

FORD/LINCOLN/MERCURY Instructions

Step 4: Follow the device prompts to ALK;

II. The location of the smart key card slot, inside the armrest box (Note: the location may be different for different models)



Esc

FORD/LINCOLN/MERCURY All Keys Lost

Switch ignition off

Enter

FORD/LINCOLN/MERCURY All Keys Lost

VIN: 1FM5K8FH0HGC71182
Part No 1: HU5T-14B476-BAK
Part No 2: HU5T-14C184-AAK

Key Count: 2

Enter

FORD/LINCOLN/MERCURY All Keys Lost

Insert the key into the card slot, the position is as follows:
1. In the armrests
2. Glove compartment

Enter

FORD/LINCOLN/MERCURY All Keys Lost

Is the alarm active?

Esc

Enter

FORD/LINCOLN/MERCURY All Keys Lost

If there is door pad on the vehicle, you may turn the alarm off by typing in the vehicle door code, if there is door pad, please input door code, then press [Enter] to continue.

Esc

Enter

FORD/LINCOLN/MERCURY All Keys Lost

Do you want to load the BCM D-flash (read by a programmer) to continue operation?

Esc

Enter

FORD/LINCOLN/MERCURY Information

Open the driver's door and use a screwdriver to set the door lock to the lock position (if the door is closed and locked), keep the door in this position until the key is learned

Instructions

Esc

Enter

FORD/LINCOLN/MERCURY Instructions

Esc

FORD/LINCOLN/MERCURY All Keys Lost

1. In the following steps, the device will automatically try to disconnect and connect the vehicle battery, please do not perform other operations;
2. When the battery is reconnected, the device will try to silence the vehicle alarm, if the operation is not successful, The device will automatically try multiple times;
3. In the following operation, you will be able to choose whether to clear the original car key.

Esc

Enter

FORD/LINCOLN/MERCURY All Keys Lost

The device is trying to disconnect the vehicle battery, please be patient...



FORD/LINCOLN/MERCURY All Keys Lost



The device is trying to connect the vehicle battery, please be patient...

FORD/LINCOLN/MERCURY All Keys Lost

Reading data...



FORD/LINCOLN/MERCURY All Keys Lost

Please wait for about 10 minutes!

At this stage, the alarm should beep in the first few minutes and then mute. Listen carefully and there will be two beeps after about 10 minutes!

While waiting, please keep quiet as much as possible. Do not touch any sensor on the car. Once you hear two beeps, press [ENTER], otherwise please wait patiently until you hear two beeps and press [ENTER] again.

Enter

FORD/LINCOLN/MERCURY All Keys Lost

Do you want to erase all keys of the current vehicle?
If yes, at least 2 keys are required to complete the key programming!

Esc

Enter

FORD/LINCOLN/MERCURY Information

Erase success

Enter

FORD/LINCOLN/MERCURY Information

You have to complete the following procedures, engine can be started:

- 1.Switch ignition off;
- 2.Insert smart key 1 into the card slot and Press Start/Stop button for 3 sec, remove the key;
- 3.Insert smart key 2 into the card slot and Press Start/Stop button for 3 sec, remove the key, complete.

(Edge key placement note:Water cup of the glove box close to the cab side, key is to go forward)

Enter