

VAG GROUP

CLIXE Emulator Instruction Manual

IMMO OFF PROGRAM



Table of contents

		PHOTO	PINOUT	VIDEO
Page 2	Program introduction			
Page 3	• Bosch EDC 1.3.3 (MSA 12-4.1)			
Page 4	• Bosch M 5.4			
Page 5	• Bosch M 3.8.4			
Page 6	• Bosch MA 1.3			
Page 7	• Bosch MP 9.0			
Page 8	• Hella MPFI			
Page 9	• Magneti Marelli IAW4AV/CV			
Page 10	• Magneti Marelli IAW4LV/MV			
Page 11	• Magneti Marelli IAW1AV			
Page 12	• Siemens 5WP4457			
Page 13	• Siemens 5WP4 340			
Page 14	• Siemens 5WP4 182			
Page 15	• Siemens 5WP4 167			
Page 16	• Siemens 5WP4 154			
Page 17	• Temic 044 906 024 E			
Page 18	• Connecting Julie Emulator - examples			
Page 19	• Example cars and ECUs full list			

● Program introduction



Program usage

**VAG group vehicles with original immobilisers - up to 2001 year
(if the VIN is not entered in the memory content)**



Example ECUs (Full list on page 19)

Bosch

0 281 001 308/309
0 261 204 956
0 261 203 914
0 261 203 897/898
0 261 203 609/610

Magneti Marelli

IAW1AV
IAW4AV
IAW4CV
IAW4LV
IAW4MV

Temic

044 906 024 E

Hella

4A0 907 473 D

Hitachi

8A0 906 266 J

Siemens

5WP4 154
5WP4 167
5WP4 340
5WP4 457



Example cars (Full list on page 19)

Audi

A3/S3 A4/S4 A6/S6 A8/S8 TT

Volkswagen

Bora Caddy Caravelle T4 Golf III Golf IV Multivan T4 New Beetle Passat B4 Passat B5 Polo Transporter T4 Vento

Seat

Alhambra Arosa Cordoba Ibiza Leon Toledo

Skoda

Fabia Octavia

● **Bosch EDC 1.3.3 (MSA 12-4.1)**

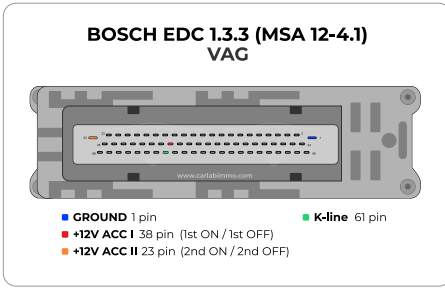

1

Connect Julie Emulator to the ECU according the picture on the right

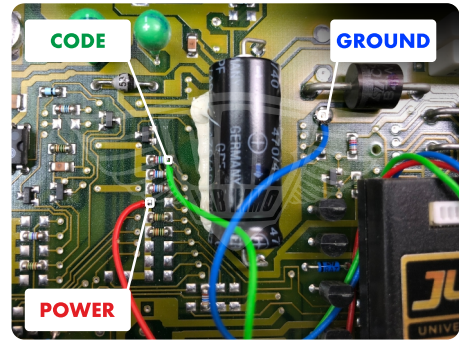

Although the picture shows Julie Emulator, the same way of connecting to ECU also applies to Clixe

i Attention!

- Disconnect immo box
- If the emulator is not working, then connect the power supply of the emulator to +12V through the reset button.
- If you want to make diagnosis connect W-line with K-line.

End of the procedure

Bosch M 5.4

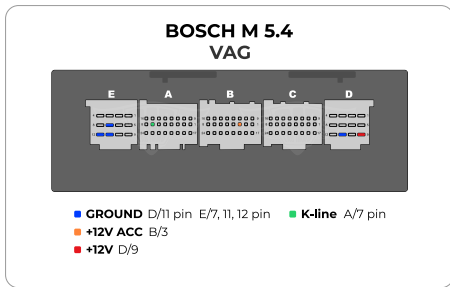

1

Connect Clixe Emulator to the ECU according to the picture on the right

GND	E7 pin
+12V ACC	B3 pin
CODE	A7 pin

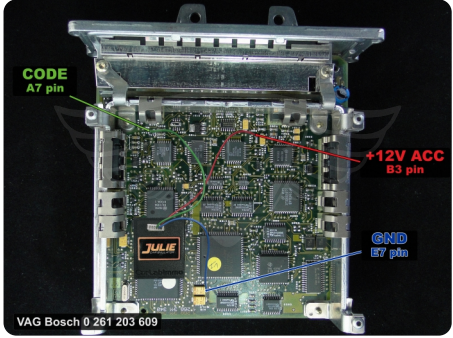

Although the picture shows Julie Emulator, the same way of connecting to ECU also applies to Clixe

i Attention!

- Cut **A7 pin** from ECU plug
- If the emulator is not working, then connect the power supply of the emulator to +12V through the reset button.
- If you want to make diagnosis connect W line with K line.

End of the procedure

● **Bosch M 3.8.4**

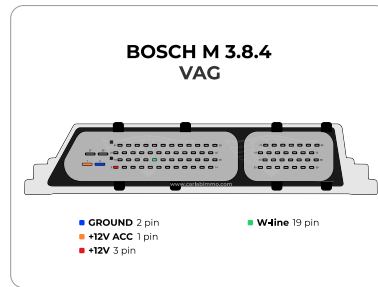

1

Connect Clixe Emulator to the ECU according to the picture on the right

GND	2 pin
+12V ACC	1 pin
CODE	19 pin

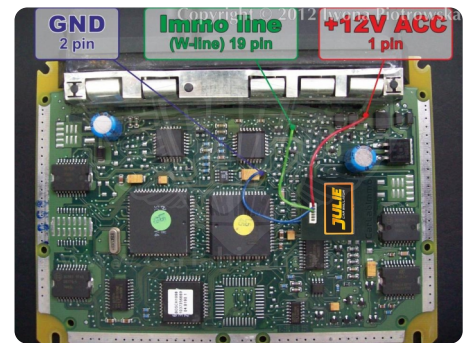

Although the picture shows Julie Emulator, the same way of connecting to ECU also applies to Clixe



Attention!

- Cut 19 pin from ECU plug
- If the emulator is not working, then connect the power supply of the emulator to +12V through the reset button.
- If you want to make diagnosis connect W-line with K-line.

End of the procedure

Bosch MA 1.3

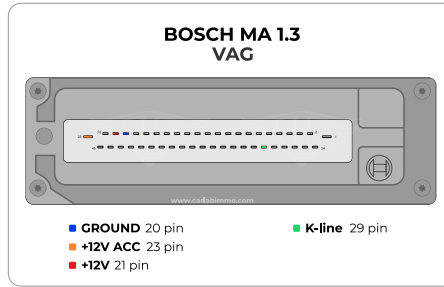

1

Connect Clixe Emulator to the ECU according the picture on the right

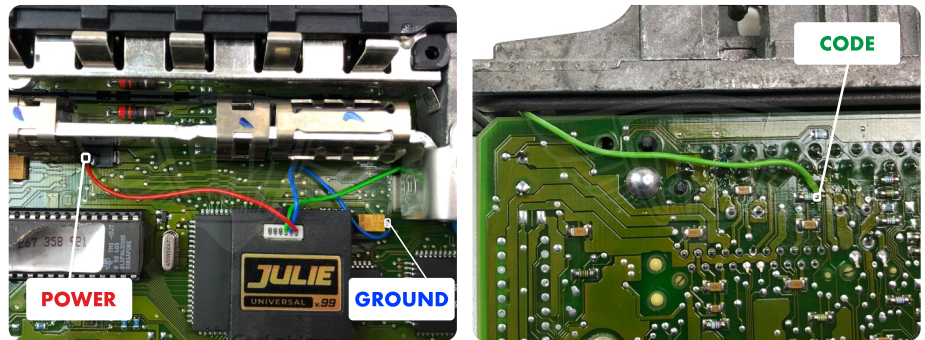

Although the picture shows Julie Emulator, the same way of connecting to ECU also applies to Clixe

i Attention!

- Disconnect immo box
- If the emulator is not working, then connect the power supply of the emulator to +12V through the reset button.
- If you want to make diagnosis connect W-line with K-line.

End of the procedure

● **Bosch MP 9.0**

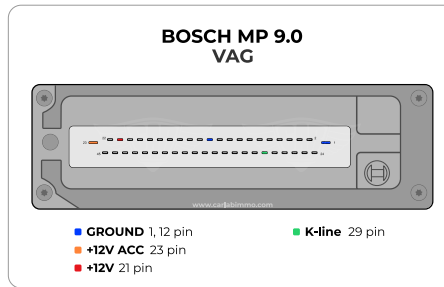

1

Connect Clixe Emulator to the ECU according the picture on the right



Although the picture shows Julie Emulator, the same way of connecting to ECU also applies to Clixe

i Attention!

- Unplug the immo box!
- If the emulator is not working, then connect the power supply of the emulator to +12V through the reset button.
- If you want to make diagnosis connect W-line with K-line.

End of the procedure

● **Hella 4A0 907 473 D**

HELLA - 4A0 907 473 D
VAG

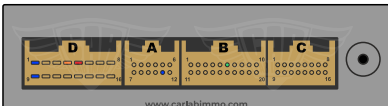

www.carshirvo.com

- **GROUND** All pin D1,9 pin ■ **K-line** B/6 pin
- **+12V ACC** D/4 pin
- **+12V** D/5 pin

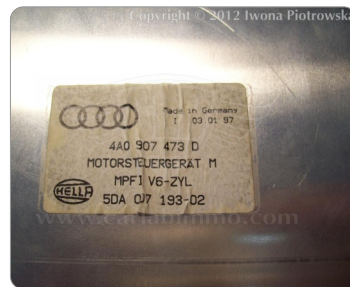

1

Connect Clixe Emulator to the ECU according to the picture on the right

GND	A11, D1, D9 pin
+12V ACC	D4 pin
CODE	B6 pin



Although the picture shows Julie Emulator, the same way of connecting to ECU also applies to Clixe



Attention!

- Cut **B6 pin** from ECU plug
- If the emulator is not working, then connect the power supply of the emulator to +12V through the reset button.
- If you want to make diagnosis connect W-line with K-line.

End of the procedure

● Magneti Marelli IAW4AV and IAW4CV

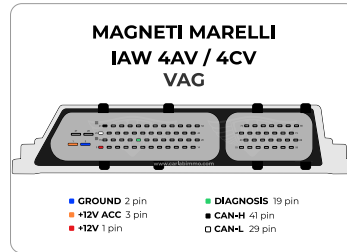

1

Connect Clixe Emulator to the ECU according to the picture on the right

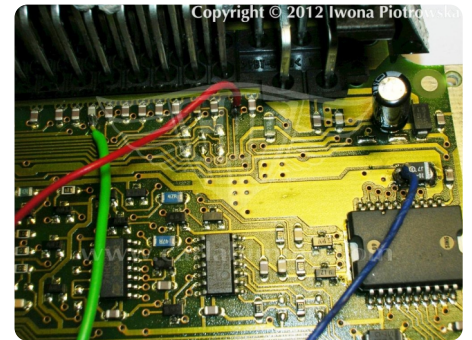
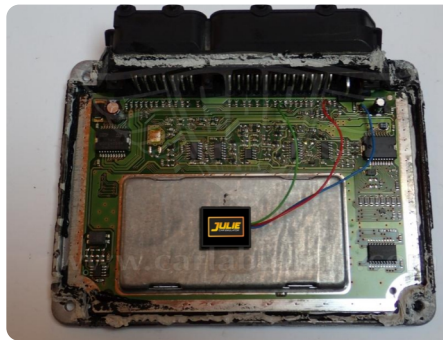

Although the picture shows Julie Emulator, the same way of connecting to ECU also applies to Clixe

Attention!

- Unplug the immo box!
- If the emulator is not working, then connect the power supply of the emulator to +12V through the reset button.
- If you want to make diagnosis connect W-line with K-line.

End of the procedure

Magneti Marelli IAW4LV and IAW4MV

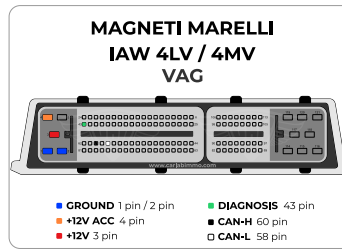

1

Connect Clixe Emulator to the ECU according to the picture on the right

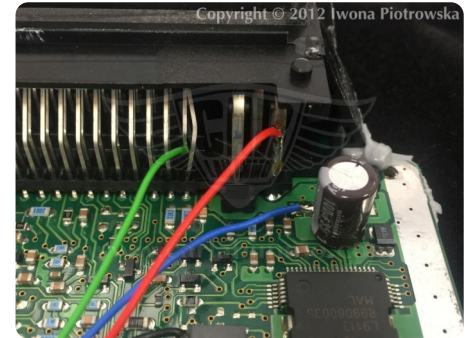
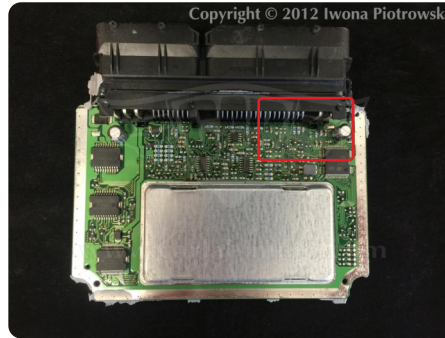

i Attention!

- Cut 43 pin from ECU plug!
- If the emulator is not working, then connect the power supply of the emulator to +12V through the reset button.
- If you want to make diagnosis connect W-line with K -line.

End of the procedure

● Magneti Marelli IAW1AV



1

Connect Julie Emulator to the ECU according to the picture below

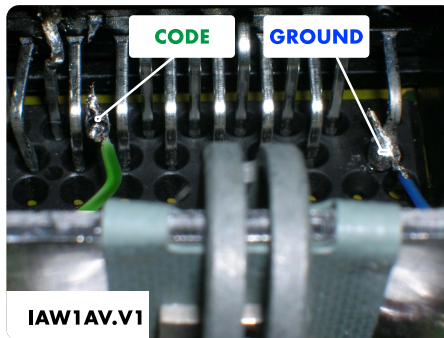
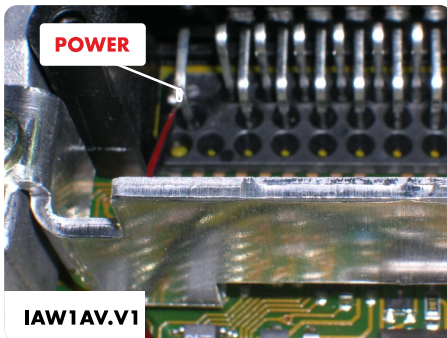

i Attention!

- Cut 29 pin from ECU plug!
- If the emulator is not working, then connect the power supply of the emulator to +12V through the reset button.
- If you want to make diagnosis connect W-line with K-line.

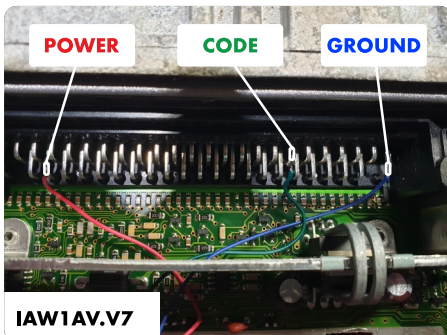

i Attention!

- If the emulator is not working, then connect the power supply of the emulator to +12V through the reset button.
- If you want to make diagnosis connect W-line with K-line.

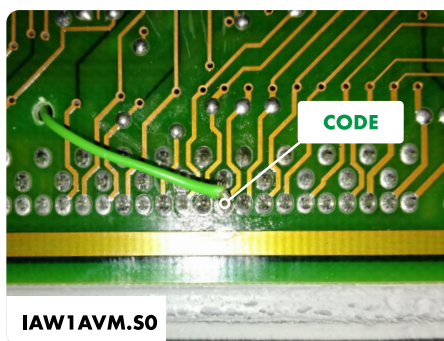
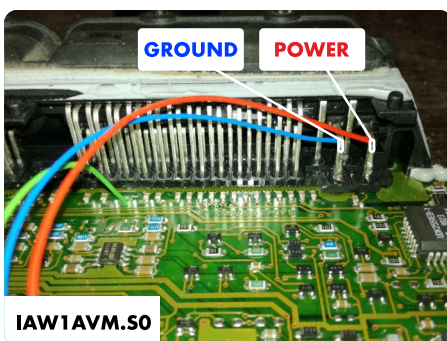

i Attention!

- Cut 19 pin from ECU plug!
- If the emulator is not working, then connect the power supply of the emulator to +12V through the reset button.
- If you want to make diagnosis connect W-line with K-line.

● **Siemens 5WP4 - 023 906 024**

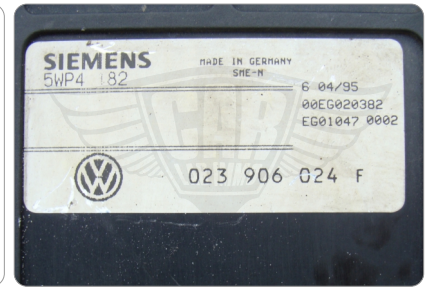
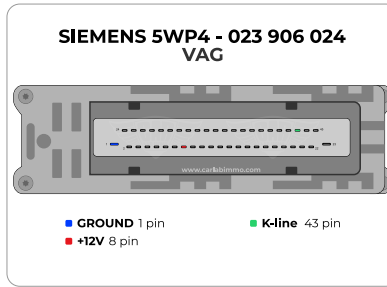

1

Connect Clixe Emulator to the ECU according the picture on the right

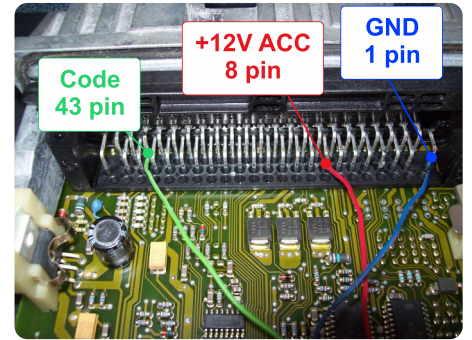

i Attention!

- Cut 43 pin from ECU plug!
- If the emulator is not working, then connect the power supply of the emulator to +12V through the reset button.
- If you want to make diagnosis connect W-line with K -line.

End of the procedure

● **Siemens 5WP4 154 - 037 906 025**

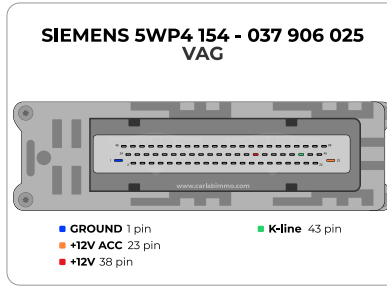

1

Connect Clixe Emulator to the ECU according to the picture on the right

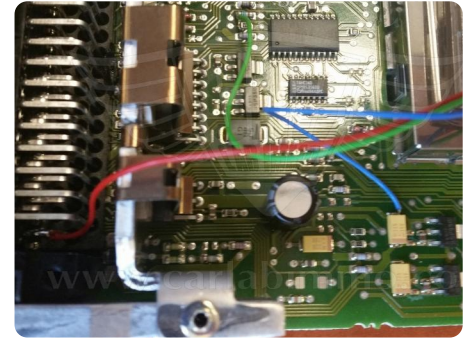

Attention!

- Cut 43 pin from ECU plug!
- If the emulator is not working, then connect the power supply of the emulator to +12V through the reset button.
- If you want to make diagnosis connect W-line with K -line.

End of the procedure

● **Siemens 5WP4 167 - 037 906 024 AE**

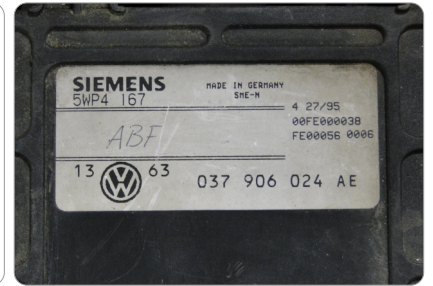
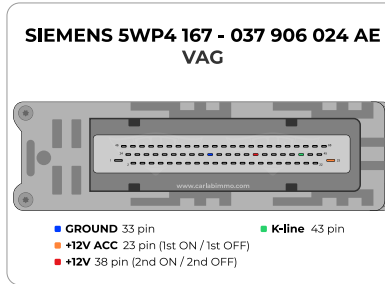

1

Connect Clixe Emulator to the ECU according to the picture on the right

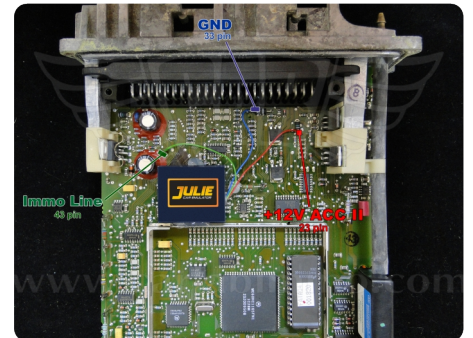

Although the picture shows Julie Emulator, the same way of connecting to ECU also applies to Clixe

i Attention!

- Cut 43 pin from ECU plug!
- If the emulator is not working, then connect the power supply of the emulator to +12V through the reset button.
- If you want to make diagnosis connect W-line with K -line.

End of the procedure

● **Siemens 5WP4 340 - 6K0 906 025 A**

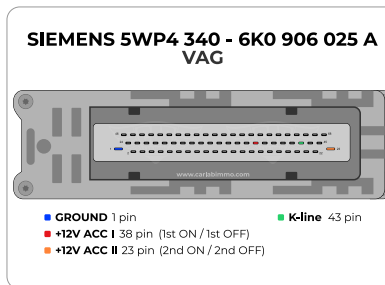

1

Connect Clixe Emulator to the ECU according to the picture on the right

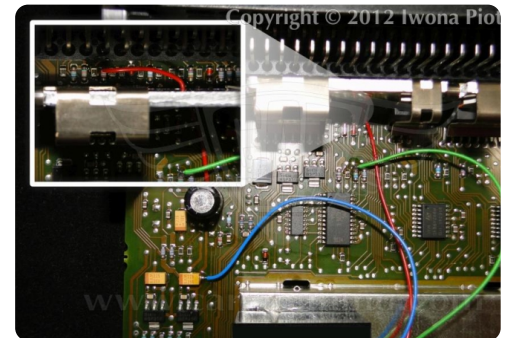

Attention!

- Cut 43 pin from ECU plug!
- If the emulator is not working, then connect the power supply of the emulator to +12V through the reset button.
- If you want to make diagnosis connect W-line with K-line.

End of the procedure

● **Siemens 5WP4 457 - 06A 906 019 BR**

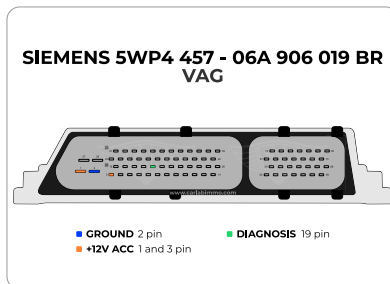

1

Connect Julie Emulator to the ECU according to the picture on the right

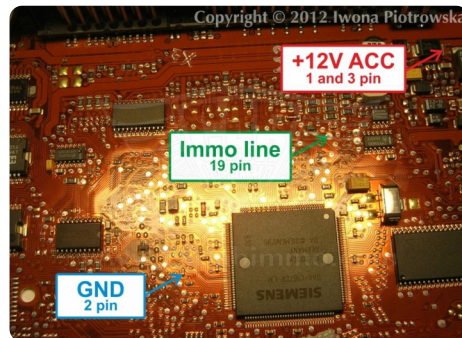

i Attention!

- Cut 19 pin from ECU plug!
- If the emulator is not working, then connect the power supply of the emulator to +12V through the reset button.
- If you want to make diagnosis connect W-line with K-line.

End of the procedure

● **Temic 044 906 024 E**



1

Connect Julie Emulator to the ECU according the diagram:

GND	PIN 1
ACC	PIN 23
CODE	PIN 43



Attention!

- Cut 43 pin from ECU plug!
- If the emulator is not working, then connect the power supply of the emulator to +12V through the reset button.
- If you want to make diagnosis connect W-line with K -line.

End of the procedure

● Connecting Clixe Emulator - examples

1

Connect Clixe Emulator according the pictures

CARS WITH IMMOBILISER INTEGRATED INTO TACHO (FROM 1998)

i Attention!

- Cut K-line and W-line off the instrument cluster!

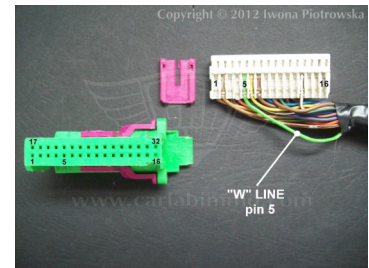
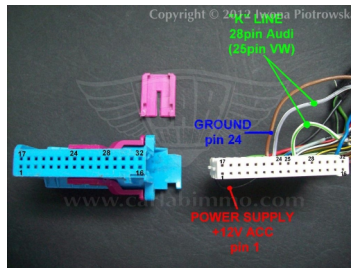

CARS WITH SEPARATE IMMOBILISER

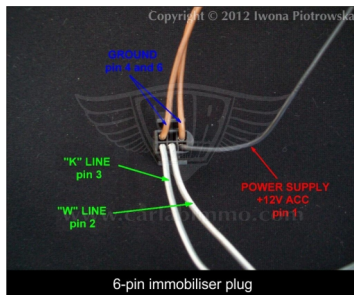

6-pin immobiliser plug

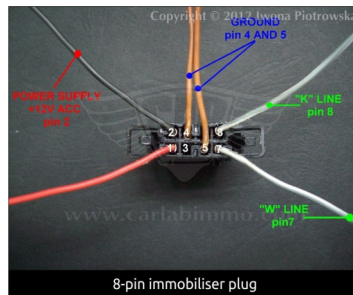

8-pin immobiliser plug

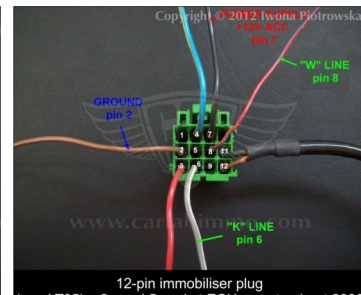

12-pin immobiliser plug (e.g. LT35) – 2 - and 5-socket ECUs up to about 2006

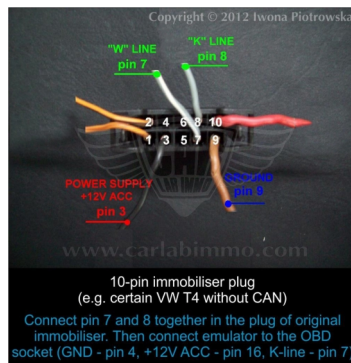

10-pin immobiliser plug (e.g. certain VW T4 without CAN)

Connect pin 7 and 8 together in the plug of original immobiliser. Then connect emulator to the OBD socket (GND - pin 4, +12V ACC - pin 16, K-line - pin 7)

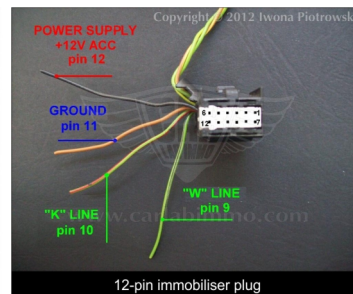

12-pin immobiliser plug

● Example cars and ECUs



Program usage



Example cars



Example ECUs

BOSCH

Bosch

EDC 1.3.3 (MSA 12-4.1)

Page 3

Volkswagen Golf III 1.9 TDi 90HP 1993-1996
Volkswagen Passat B4 1.9 TDi 90HP 1993-1996
Volkswagen Vento 1.9 TDi 90HP 1993-1998

0 281 001 415/416 / 028 906 021 DC (Volkswagen Passat B4 1.9 TDi 90HP 1995)
0 281 001 413/414 / 028 906 021 DM (Volkswagen Passat B4 1.9 TDi 90HP 1995)
0 281 001 411/412 / 028 906 021 DD (Volkswagen Passat B4 1.9 TDi 90HP 1995)
0 281 001 323/324 / 028 906 021 AH (Volkswagen Passat B4 1.9 TDi 90HP 1994)
0 281 001 310/311 / 028 906 021 AG (Volkswagen Golf III 1.9 TDi 90HP 1995)
0 281 001 308/309 / 028 906 021 AF (Volkswagen Vento 1.9 TDi 90HP 1995)
0 281 001 247/248 / 028 906 021 BJ (Volkswagen Golf III 1.9 TDi 90HP 1996)
0 281 001 241/242 / 028 906 021 Q (Volkswagen Passat B4 1.9 TDi 90HP 1995)
0 281 001 170/171 / 028 906 021 C (Volkswagen Golf III 1.9 TDi 90HP 1994)

Bosch

M 5.4

Page 4

Audi A8 D2 4.2 300HP 1994-1999

0 261 204 146/147 / 4D0 907 557 J (Audi A8 D2 4.2 300HP 1995)
0 261 203 609/610 / 4D0 907 557 E (Audi A8 D2 4.2 300HP 1996)
0 261 203 299/300 / 4D0 907 557 B (Audi A8 D2 4.2 300HP 1998)

Bosch

M 3.8.4

Page 5

Audi A6 C5 1.8 125HP 1995-1997
Audi A4 B5 1.8 125HP 1994-1999
Volkswagen Passat B5 1.8 125HP 1996-1999

0 261 204 957 / 8D0 907 558 T (Audi A4 B5 1.8 125HP 1998)
0 261 204 956 / 8D0 907 558 S (Volkswagen Passat 1.8 B5 125HP 1997)
0 261 204 774 / 8D0 907 558 B (Audi A4 B5 1.8 125HP 1996)
0 261 204 773 / 8D0 907 558 G (Volkswagen Passat B5 1.8 125HP 1998)
0 261 204 252 / 4B0 907 557 (Audi A6 C5 1.8 125HP 1996)

Bosch

MA 1.3

Page 6

Volkswagen Golf III 1.6 75HP 1994-1997
Volkswagen Polo III 6N 1.6 75HP 1995-1999

0 261 203 897/898 / 032 906 026 H (Volkswagen Polo III 6N 1.6 1995)
0 261 203 456/457 / 030 906 026 AJ (Volkswagen Polo III 6N 1.3 1998)
0 261 203 314/315 / 032 906 026 D (Volkswagen Golf III 1.6 75HP 1995)
0 261 203 308/309 / 032 906 026 B (Volkswagen Polo III 6N 1.6 75HP 1994)

Bosch

MP 9.0

Page 7

Seat Arosa 1.4 60HP 1997-2005
Seat Arosa 1.0 50HP 1997-2005
Seat Cordoba 1.4 75HP 1999-2002
Seat Ibiza 6K 1.4 60HP 1996-2000
Seat Ibiza 6K 1.0 50HP 1996-2000
Volkswagen Fox 1.4 75HP 2005-2011
Volkswagen Golf IV 1.4 75HP 1997-2003
Volkswagen Lupo 1.0 50HP 1998-2005
Volkswagen Polo III 6N 1.6 75HP 1996-2000
Volkswagen Polo III 6N 1.4 60HP 1995-2001
Volkswagen Polo III 6N 1.0 50HP 1996-2001

0 261 206 248 / 377 906 021 FQ (Volkswagen Polo III 6N 1.0 50HP 2001)
0 261 206 230 / 030 906 027 AR (Volkswagen Golf IV 1.4 75HP 1999)
0 261 206 226 / 030 906 027 AL (Volkswagen Lupo 1.0 50HP 1999)
0 261 206 178 / 377 906 021 FA (Volkswagen Polo III 6N 1.0 50HP 2001)
0 261 206 118 / 377 906 021 FH (Volkswagen Polo III 6N 1.0 50HP 2000)
0 261 204 844 / 6K0 906 027 J (Seat Ibiza 6K 1.4 60HP 1998)
0 261 204 824 / 030 906 027 AJ (Volkswagen Polo III 6N 1.0 50HP 2001)
0 261 204 823 / 030 906 027 AH (Seat Arosa 1.0 50HP 1999)
0 261 204 797 / 030 906 027 AT (Seat Arosa 1.4 60HP 1998)
0 261 204 796 / 030 906 027 AG (Seat Arosa 1.4 60HP 1999)
0 261 204 795 / 030 906 027 AS (Volkswagen Polo III 6N 1.4 60HP 1999)
0 261 204 740 / 377 906 021 DQ (Volkswagen Polo III 6N 1.0 50HP 1998)
0 261 204 618/619 / 030 906 027 AB (Volkswagen Polo III 6N 1.4 60HP 2000)
0 261 204 616/617 / 030 906 027 AA (Volkswagen Polo III 6N 1.4 60HP 2001)
0 261 204 593 / 6K0 906 027 E (Seat Cordoba 1.4 75HP 2002)
0 261 204 441 / 030 906 027 Q (Seat Arosa 1.4 60HP 2001)
0 261 204 436 / 030 906 027 (Seat Arosa 1.4 60HP 1998)
0 261 204 435 / 030 906 027 (Seat Arosa 1.4 60HP 1999)
0 261 204 272 / 377 906 021 AN (Volkswagen Polo III 6N 1.4 60HP 2000)
0 261 204 158 / 6KS 906 258 G (Volkswagen Polo III 6N 1.4 60HP 1999)
0 261 204 157 / 6KS 906 258 B (Volkswagen Polo III 6N 1.6 60HP 1998)
0 261 204 153/154 / 030 906 027 L (Volkswagen Polo III 6N 1.4 60HP 1999)
0 261 204 054/055 / 6K0 906 027 A (Volkswagen Fox 1.4 75HP 2005)
0 261 204 023 / 030 906 027 AH (Volkswagen Lupo 1.0 50 HP 1999)
0 261 203 933/934 / 6K0 906 027 D (Seat Ibiza 6K 1.0 50HP 1998)
0 261 203 931/932 / 030 906 027 E (Volkswagen Polo III 6N 1.0 50HP 1997)
0 261 203 929/930 / 030 906 027 J (Seat Arosa 1.0 50HP 1997)
0 261 203 916/917 / 030 906 027 C (Seat Arosa 1.4 60HP 2003)
0 261 203 914/915 / 030 906 027 A (Volkswagen Polo III 6N 1.4 60HP 2000)
0 261 203 752/753 / 6K0 907 311 B (Volkswagen Polo III 6N 1.4 60HP 2001)
0 261 203 613/614 / 030 906 027 T (Seat Arosa 1.4 60HP 2001)

List continues on the next page

● Example cars and ECUs



Program usage



Example cars



Example ECUs

HELLA

Hella

MPFI

Page 8

Audi A6 C4 2.6 150HP 1994-1997
Audi A4 B5 2.6 150HP 1994-1997
Audi 80 B4 2.6 150HP 1992-1995

4A0 907 473 D / 5DA 007 193-02 (Audi A6 C4 2.6 150HP 1995)
4A0 907 473 K / 5DA 007 193-10 (Audi 80 B4 2.6 150HP 1994)
4A0 907 473 L / 5DA 007 193-11 (Audi A4 B5 2.6 150HP 1996)
4A0 907 473 T / 5DA 007 193-53 (Audi A6 C4 2.6 150HP 1996)
4A0 907 473 E / 5DA 007 193-03 (Audi A4 B5 2.6 150HP 1997)

MAGNETI MARELLI

Magneti Marelli

IAW 4AV.x /4CV.x

Page 9

Seat Leon I 1.4 75HP 1999-2005
Volkswagen Golf IV 1.6 105HP 1999-2003
Volkswagen Golf IV 1.4 75HP 1997-2003

036 906 014 (Volkswagen Golf IV 1.4 75HP 1998)
036 906 014 AA (Volkswagen Golf IV 1.4 75HP 1998)
036 906 014 AN (Volkswagen Golf IV 1.4 75HP 2002)
036 906 014 AQ (Seat Leon I 1.4 75HP 2003)
036 906 014 M (Volkswagen Golf IV 1.4 75HP 1998)

Magneti Marelli

IAW 4LV.x /4MV.x

Page 10

Seat Ibiza II 1.4 75HP 2000-2002
Seat Leon I 1.6 105HP 2000-2006
Skoda Fabia 1.4 101HP 1999-2007
Volkswagen Golf IV 1.6 105HP 1999-2003
Volkswagen Polo 6N2 1.4 75HP 1999-2001
Volkswagen Polo 6N 1.4 100HP 1996-1999
Volkswagen Polo 6N 1.4 75HP 1999-2001

6K0 906 034 D (Seat Ibiza II 1.4 75HP 2001)
6K0 906 034 E (Volkswagen Polo 6N2 1.4 75HP 2000)
6K0 906 034 (Seat Ibiza II 1.4 75HP 2001)
036 906 034 AK (Volkswagen Polo 6N 1.4 100HP 1998)
036 906 034 BB (Volkswagen Golf IV 1.6 105HP 2001)
036 906 034 BD (Seat Leon I 1.6 105HP 2002)
036 906 034 BH (Volkswagen Golf IV 1.6 105HP 2000)
036 906 034 BK (Skoda Fabia 1.4 101HP 2002)
036 906 034 D (Volkswagen Polo 6N 1.4 75HP 2000)

Magneti Marelli

IAW1AV

Page 11

Volkswagen Golf 1.6 75HP 1995-1997
Skoda Octavia 1.6 75HP 1996-2001
Seat Ibiza 1.6 75HP 1994-1999

032 906 030 G (Volkswagen Golf 1.6 75HP 1995)
032 906 014 F (Skoda Octavia 1.6 75HP 1998)
6K0 906 030 E (Seat Ibiza 1.6 75HP 1998)

SIEMENS

Siemens

5WP4 457

Page 12

Seat Leon I 1.6 100HP 1999-2000

06A 906 019 BR (Seat Leon I 1.6 100HP 1999)

Siemens

5WP4 340

Page 13

Seat Toledo 1.6 100HP 1998-2000

6K0 906 025 A (Seat Toledo 1.6 100HP 1999)

Siemens

5WP4 182

Page 14

Seat Toledo 1.6 100HP 1998-2000

6K0 906 025 A (Seat Toledo 1.6 100HP 1999)

Siemens

5WP4 167

Page 15

Volkswagen Golf III 2.0 115HP 1994-1997

023 906 024 AE (Volkswagen Golf III 2.0 115HP 1995)

Siemens

5WP4 154

Page 16

Volkswagen Passat B4 2.0 116HP 1993-1997

037 906 025 (Volkswagen Passat B4 2.0 116HP 1995)

● Example cars and ECUs



Program usage



Example cars



Example ECUs

TEMIC

Temic
Page 17

Volkswagen T4 2.0 1999

044 906 024 E (Volkswagen T4 2.0 1999)

VAG GROUP VEHICLES WITH 1.9 and 2.5 DIESEL ENGINE

VAG group
1.9 and 2.5
diesel engines
Page 18

Audi A6 C5 2.5 TDi 150HP 1997-2001	0 281 011 385 / 074 906 018 BK (Volkswagen LT 2.5 TDi 109HP 2000)
Audi A6 C4 2.5 TDi 140HP 1994-1997	0 281 011 321 / 038 906 012 HR (Skoda Fabia 1.9 SDi 64HP 2004)
Audi A6 C4 2.5 TDi 115HP 1994-1997	0 281 010 639 / 074 906 018 BC (Volkswagen LT 2.5 TDi 109HP 2002)
Audi A6 C5 1.9 TDi 130HP 2001-2005	0 281 010 638 / 074 906 018 BD (Volkswagen LT 2.5 TDi 109HP 2001)
Audi A6 C5 1.9 TDi 110HP 1997-2001	0 281 010 631 / 074 906 018 BG (Volkswagen T4 2.5 TDi 102HP 2001)
Audi A6 C4 1.9 TDi 90HP 1994-1996	0 281 010 588 / 2D0 906 019 A (Volkswagen LT 2.8 TDi 158HP 2005)
Audi A4 B5 1.9 TDi 115HP 1999-2001	0 281 010 497 / 038 906 019 DF (Volkswagen Passat B5 1.9 TDi 100HP 2000)
Audi A4 B5 1.9 TDi 110HP 1996-2000	0 281 010 458 / 074 906 018 AM (Volkswagen T4 2.5 TDi 102HP 1998)
Audi A4 B5 1.9 TDi 90HP 1995-2001	0 281 010 407 / 074 906 018 H (Volkswagen LT 2.5 TDi 102HP 1999)
Audi A3 8L 1.9 TDi 110HP 1997-2001	0 281 010 405 / 038 906 019 CF (Audi A6 C5 1.9 TDi 130HP 2001-2005)
Audi A3 8L 1.9 TDi 90HP 1996-2001	0 281 010 393 / 4B1 907 401 A (Audi A6 2.5 TDi 150HP 1999)
Seat Alhambra I 1.9 TDi 110HP 1996-2000	0 281 010 373 / 038 906 012 DB (Volkswagen Golf IV 1.9 SDi 68HP 1999)
Seat Cordoba I 1.9 TDi 110HP 1999-2002	0 281 010 309 / 038 906 019 CA (Volkswagen Sharan I 1.9 TDi 90HP 1999)
Seat Ibiza 6K 1.9 TDi 90HP 1996-1999	0 281 010 303 / 038 906 019 AJ (Volkswagen Golf IV 1.9 TDi 115HP 2000)
Seat Ibiza 6K 1.9 SDi 68HP 1999-2002	0 281 010 302 / 038 906 019 CJ (Volkswagen Golf IV 1.9 TDi 115HP 2001)
Seat Toledo 1L 1.9 TDi 110HP 1996-2004	0 281 010 244 / 038 906 018 GQ (Volkswagen Golf IV 1.9 TDi 110HP 2001)
Skoda Fabia 1.9 SDi 64HP 1999-2005	0 281 010 218 / 038 906 019 CD (Volkswagen Passat B5 1.9 TDi 115HP 2000)
Skoda Octavia I 1.9 TDi 90HP 1996-2005	0 281 010 217 / 038 906 019 CE (Volkswagen Passat B5 1.9 TDi 115HP 1999)
Volkswagen Bora 1.9 TDi 115HP 1999-2001	0 281 010 216 / 038 906 019 J (Volkswagen Sharan I 1.9 TDi 115HP 2000)
Volkswagen Caddy 1.9 SDi 64HP 1995-2003	0 281 010 215 / 038 906 019 AR (Volkswagen Polo 6N 1.9 SDi 64HP 1998)
Volkswagen Caddy 1.9 TDi 90HP 2000-2003	0 281 010 202 / 038 906 012 AJ (Audi A4 B5 1.9 TDi 90HP 1998)
Volkswagen Caddy 1.7 SDi 57HP 1996-2000	0 281 010 200 / 038 906 012 AH (Audi A4 B5 1.9 TDi 110HP 1999)
Volkswagen Golf IV 1.9 TDi 115HP 1999-2001	0 281 010 179 / 038 906 012 BE (Volkswagen Lupo 1.7 SDi 60HP 2000)
Volkswagen Golf IV 1.9 TDi 110HP 1997-2002	0 281 010 176 / 038 906 019 BJ (Volkswagen Passat B5 1.9 TDi 115HP 1999)
Volkswagen Golf IV 1.9 TDi 90HP 1997-2002	0 281 010 174 / 038 906 012 BF (Volkswagen Golf IV 1.9 SDi 68HP 1998)
Volkswagen Golf IV 1.9 SDi 68HP 1997-2003	0 281 010 170 / 038 906 018 GA (Volkswagen Passat B5 1.9 TDi 110HP 1997)
Volkswagen Golf III 1.9 TDi 110HP 1996-1997	0 281 010 153 / 4B0 907 401 T (Audi A6 C5 2.5 TDi 150HP 1999)
Volkswagen Golf III 1.9 TDi 90HP 1993-1997	0 281 010 126 / 038 906 012 AP (Volkswagen Golf IV 1.9 TDi 110HP 2002)
Volkswagen Golf III 1.9 SDi 64HP 1995-1997	0 281 010 122 / 038 906 012 C (Volkswagen Golf IV 1.9 TDi 90HP 2000)
Volkswagen LT 2.8 TDi 158HP 2002-2006	0 281 010 112 / 038 906 012 L (Volkswagen Golf IV 1.9 TDi 110HP 2000)
Volkswagen LT 2.5 TDi 109HP 1999-2006	0 281 010 111 / 038 906 012 K (Volkswagen Golf IV 1.9 TDi 90HP 1999)
Volkswagen LT 2.5 TDi 102HP 1996-1999	0 281 010 104 / 038 906 012 (Volkswagen Golf IV 1.9 SDi 68HP 1997)
Volkswagen Lupo 1.7 SDi 60HP 1998-2005	0 281 010 094 / 038 906 019 AN (Audi A4 B5 1.9 TDi 115HP 1999)
Volkswagen New Beetle 1.9 TDi 90HP 1998-2004	0 281 010 091 / 038 906 019 AM (Volkswagen Golf IV 1.9 TDi 115HP 2001)
Volkswagen Passat B5 1.9 TDi 115HP 1999-2000	0 281 010 088 / 074 906 021 AG (Volkswagen T4 2.5 TDi 102HP 1998)
Volkswagen Passat B5 1.9 TDi 110HP 1996-2000	0 281 010 084 / 074 906 018 B (Volkswagen T4 2.5 TDi 88HP 1999)
Volkswagen Passat B5 1.9 TDi 100HP 2000-2000	0 281 010 082 / 074 906 018 C (Volkswagen T4 2.5 TDi 102HP 2000)
Volkswagen Passat B5 1.9 TDi 90HP 1996-2000	0 281 010 078 / 074 906 018 N (Volkswagen T4 2.5 TDi 151HP 2001)
Volkswagen Passat B4 1.9 TDi 90HP 1993-1996	0 281 010 064 / 038 906 018 FE (Volkswagen Passat B5 1.9 TDi 110HP 1999)
Volkswagen Polo 6N2 1.4 TDi 75HP 1999-2001	0 281 010 057 / 038 906 018 FK (Volkswagen Caddy 1.9 TDi 90HP 2001)
Volkswagen Polo 6N 1.9 SDi 64HP 1995-1999	0 281 010 007 / 038 906 013 AN (Volkswagen Caddy 1.9 SDi 64HP 2001)
Volkswagen Polo 6N 1.7 SDi 60HP 1997-1999	0 281 010 006 / 038 906 018 FB (Seat Cordoba I 1.9 TDi 110HP 2000)
Volkswagen Sharan I 1.9 TDi 115HP 2000-2010	0 281 001 979 / 038 906 012 M (Volkswagen Golf IV 1.9 TDi 90HP 2001)
Volkswagen Sharan I 1.9 TDi 110HP 1996-2000	0 281 001 968 / 028 906 021 JK (Volkswagen Sharan I 1.9 TDi 110HP 2002)
Volkswagen Sharan I 1.9 TDi 90HP 1996-2000	0 281 001 940 / 045 906 019 (Volkswagen Polo 6N2 1.4 TDi 75HP 1999)
Volkswagen T4 2.5 TDi 151HP 1998-2003	0 281 001 926 / 038 906 018 BT (Seat Toledo 1L 1.9 TDi 110HP 1999)
Volkswagen T4 2.5 TDi 102HP 1995-2003	0 281 001 914 / 038 906 018 EC (Seat Ibiza 6K 1.9 TDi 90HP 1998)
Volkswagen T4 2.5 TDi 88HP 1998-2003	0 281 001 911 / 038 906 013 AB (Seat Ibiza 6K 1.9 SDi 68HP 2000)
Volkswagen Vento 1.9 TDi 90HP 1996-1998	0 281 001 910 / 038 906 019 H (Volkswagen Bora 1.9 TDi 115HP 1999)
	0 281 001 851 / 038 906 018 AE (Volkswagen Golf IV 1.9 TDi 90HP 1998)
	0 281 001 849 / 038 906 018 BQ (Skoda Octavia I 1.9 TDi 90HP 2002)
	0 281 001 848 / 038 906 018 BP (Audi A3 8L 1.9 TDi 110HP 2001)
	0 281 001 846 / 038 906 018 BM (Volkswagen Golf IV 1.9 TDi 110HP 1999)
	0 281 001 845 / 038 906 018 BL (Volkswagen Golf IV 1.9 TDi 90HP 1998)
	0 281 001 808 / 038 906 018 DG (Audi A6 C5 1.9 TDi 110HP 1999)
	0 281 001 757 / 038 906 018 BB (Audi A3 8L 1.9 TDi 90HP 1998)
	0 281 001 756 / 038 906 018 BA (Audi A3 8L 1.9 TDi 110HP 1997)
	0 281 001 755 / 038 906 018 BC (Skoda Octavia I 1.9 TDi 90HP 2004)
	0 281 001 749 / 038 906 013 K (Volkswagen Polo 6N 1.7 SDi 60HP 1998)
	0 281 001 738 / 028 906 021 GS (Seat Alhambra I 1.9 TDi 110HP 1998)

List continues on the next page

● Example cars and ECUs



Program usage



Example cars



Example ECUs

VAG GROUP VEHICLES WITH 1.9 DIESEL ENGINE

VAG group 1.9 and 2.5 diesel engines Page 18

Audi A6 C5 2.5 TDi 150HP 1997-2001	0 281 001 737 / 028 906 021 HC (Volkswagen Sharan I 1.9 TDi 90HP 1998)
Audi A6 C4 2.5 TDi 140HP 1994-1997	0 281 001 733 / 038 906 018 AN (Volkswagen Golf IV 1.9 TDi 90HP 1999)
Audi A6 C4 2.5 TDi 115HP 1994-1997	0 281 001 732 / 038 906 018 AP (Volkswagen New Beetle 1.9 TDi 90HP 1999)
Audi A6 C5 1.9 TDi 130HP 2001-2005	0 281 001 729 / 028 906 021 HD (Volkswagen Caddy 1.9 TDi 90HP 2002)
Audi A6 C5 1.9 TDi 110HP 1997-2001	0 281 001 728 / 038 906 018 AR (Audi A3 8L 1.9 TDi 90HP 2000)
Audi A6 C4 1.9 TDi 90HP 1994-1996	0 281 001 727 / 038 906 018 N (Volkswagen Passat B5 1.9 TDi 90HP 1998)
Audi A4 B5 1.9 TDi 115HP 1999-2001	0 281 001 726 / 038 906 018 R (Audi A4 B5 1.9 TDi 90HP 1999)
Audi A4 B5 1.9 TDi 110HP 1996-2000	0 281 001 724 / 038 906 018 AS (Volkswagen Passat B5 1.9 TDi 90HP 1998)
Audi A4 B5 1.9 TDi 90HP 1995-2001	0 281 001 720 / 038 906 018 P (Volkswagen Passat B5 1.9 TDi 110HP 1998)
Audi A3 8L 1.9 TDi 110HP 1997-2001	0 281 001 694 / 038 906 018 AJ (Audi A3 8L 1.9 TDi 110HP 2000)
Audi A3 8L 1.9 TDi 90HP 1996-2001	0 281 001 693 / 038 906 018 AH (Audi A3 8L 1.9 TDi 110HP 1997)
Seat Alhambra I 1.9 TDi 110HP 1996-2000	0 281 001 689 / 038 906 013 E (Volkswagen Caddy 1.9 SDi 64HP 1998)
Seat Cordoba I 1.9 TDi 110HP 1999-2002	0 281 001 679 / 038 906 013 D (Volkswagen Polo 6N 1.9 SDi 64HP 1998)
Seat Ibiza 6K 1.9 TDi 90HP 1996-1999	0 281 001 655/656 / 028 906 021 GL (Volkswagen Passat B5 1.9 TDi 110HP 1997)
Seat Ibiza 6K 1.9 SDi 68HP 1999-2002	0 281 001 651 / 028 906 021 GH (Volkswagen Golf III 1.9 TDi 110HP 1997)
Seat Toledo 1L 1.9 TDi 110HP 1996-2004	0 281 001 649/650 / 028 906 021 GG (Volkswagen Vento 1.9 TDi 90HP 1997)
Skoda Fabia 1.9 SDi 64HP 1999-2005	0 281 001 640 / 074 906 021 L (Volkswagen T4 2.5 TDi 102HP 1999)
Skoda Octavia I 1.9 TDi 90HP 1996-2005	0 281 001 640 / 074 906 021 L (Volkswagen T4 2.5 TDi 102HP 1997)
Volkswagen Bora 1.9 TDi 115HP 1999-2001	0 281 001 613 / 038 906 018 J (Volkswagen Golf IV 1.9 TDi 110HP 1999)
Volkswagen Caddy 1.9 SDi 64HP 1995-2003	0 281 001 613 / 038 906 018 J (Volkswagen Golf IV 1.9 TDi 110HP 1998)
Volkswagen Caddy 1.9 TDi 90HP 2000-2003	0 281 001 609 / 038 906 018 G (Audi A6 C4 1.9 TDi 90HP 1995)
Volkswagen Caddy 1.7 SDi 57HP 1996-2000	0 281 001 599 / 074 906 021 J (Volkswagen LT 2.5 TDi 102HP 1997)
Volkswagen Golf IV 1.9 TDi 115HP 1999-2001	0 281 001 598 / 074 906 021 P (Volkswagen LT 2.5 TDi 102HP 1999)
Volkswagen Golf IV 1.9 TDi 110HP 1997-2002	0 281 001 584 / 028 906 021 EK (Volkswagen Golf III 1.9 TDi 110HP 1998)
Volkswagen Golf IV 1.9 TDi 90HP 1997-2002	0 281 001 582 / 028 906 021 EF (Seat Toledo 1L 1.9 TDi 110HP 1998)
Volkswagen Golf IV 1.9 SDi 68HP 1997-2003	0 281 001 557/588 / 028 906 021 EG (Volkswagen Passat B5 1.9 TDi 110HP 1997)
Volkswagen Golf III 1.9 TDi 110HP 1996-1997	0 281 001 532/533 / 028 906 021 EJ (Volkswagen Caddy 1.7 SDi 57HP 1996)
Volkswagen Golf III 1.9 TDi 90HP 1993-1997	0 281 001 486 / 028 906 021 DL (Volkswagen Caddy 1.9 TDi 90HP 2002)
Volkswagen Golf III 1.9 SDi 64HP 1995-1997	0 281 001 484 / 028 906 021 DK (Seat Ibiza 6K 1.9 TDi 90HP 1998)
Volkswagen LT 2.8 TDi 158HP 2002-2006	0 281 001 472/473 / 028 906 021 DF (Volkswagen Golf III 1.9 TDi 110HP 1996)
Volkswagen LT 2.5 TDi 109HP 1999-2006	0 281 001 469/470 / 074 906 021 F (Volkswagen T4 2.5 TDi 102HP 2000)
Volkswagen LT 2.5 TDi 102HP 1996-1999	0 281 001 425/426 / 028 906 021 CE (Audi A4 B5 1.9 TDi 110HP 1999)
Volkswagen Lupo 1.7 SDi 60HP 1998-2005	0 281 001 423 / 028 906 021 CK (Volkswagen Passat B5 1.9 TDi 110HP 1998)
Volkswagen New Beetle 1.9 TDi 90HP 1998-2004	0 281 001 421/422 / 028 906 021 BF (Volkswagen Golf III 1.9 TDi 90HP 1996)
Volkswagen Passat B5 1.9 TDi 115HP 1999-2000	0 281 001 411/412 / 028 906 021 DD (Volkswagen Passat B4 1.9 TDi 90HP 1996)
Volkswagen Passat B5 1.9 TDi 110HP 1996-2000	0 281 001 407/408 / 028 906 021 CQ (Volkswagen Caddy 1.9 SDi 64HP 1997)
Volkswagen Passat B5 1.9 TDi 100HP 2000-2000	0 281 001 366/367 / 028 906 021 F (Audi A4 B5 1.9 TDi 90HP 1995)
Volkswagen Passat B5 1.9 TDi 90HP 1996-2000	0 281 001 354/355 / 028 906 021 BT (Volkswagen Golf III 1.9 TDi 90HP 1997)
Volkswagen Passat B4 1.9 TDi 90HP 1993-1996	0 281 001 343/344 / 028 906 021 BP (Volkswagen Golf III 1.9 SDi 64HP 1996)
Volkswagen Polo 6N2 1.4 TDi 75HP 1999-2001	0 281 001 320/321 / 4A0 907 401 P (Audi A6 C4 2.5 TDi 140HP 1995)
Volkswagen Polo 6N 1.9 SDi 64HP 1995-1999	0 281 001 316/317 / 028 906 021 AP (Audi A4 B5 1.9 TDi 90HP 1995)
Volkswagen Polo 6N 1.7 SDi 60HP 1997-1999	0 281 001 312/313 / 028 906 021 AK (Volkswagen Passat B4 1.9 TDi 90HP 1994)
Volkswagen Sharan I 1.9 TDi 115HP 2000-2010	0 281 001 308/309 / 028 906 021 AF (Volkswagen Golf III 1.9 TDi 90HP 1995)
Volkswagen Sharan I 1.9 TDi 110HP 1996-2000	0 281 001 306 / 074 906 021 A (Volkswagen T4 2.5 TDi 102HP 2000)
Volkswagen Sharan I 1.9 TDi 90HP 1996-2000	0 281 001 255/256 / 4A0 907 401 F (Audi A6 C4 2.5 TDi 115HP 1996)
Volkswagen T4 2.5 TDi 151HP 1998-2003	0 281 001 253/254 / 4A0 907 401 E (Audi A6 C4 2.5 TDi 115HP 1996)
Volkswagen T4 2.5 TDi 102HP 1995-2003	0 281 001 251/252 / 028 906 021 P (Seat Alhambra I 1.9 TDi 110HP 1998)
Volkswagen T4 2.5 TDi 88HP 1998-2003	
Volkswagen Vento 1.9 TDi 90HP 1996-1998	